



CORONET WOODWORKING MACHINES



MINOR Lathe and Attachments

5¹/₂



MINORETTE – Basic Unit (plus Cabinet Stand)



MAJOR – With Attachments



MAJORETTE – With Attachments

FOREWORD & GENERAL INFORMATION

For almost 25 years, the Coronet Tool Company have been famous for their Universal Woodworking Machines known throughout the World as the MINOR, MINORETTE, MAJOR AND MAJORETTE. These years of valuable experience have gone into the present range of equipment, the latest being the New IMP BANDSAW.

Coronet machines are designed to meet all the needs of the professional tradesman as well as the Do-It-Yourself enthusiast. The comprehensive range of tools and accessories are not merely attachments, they have been developed to equal the performance of independent machines and the use of a powerful double ended motor enables several of these to be operated at any one time without the necessity of removing the others.

The multi-speed spindle in the headstock is carried in a conical, easily adjusted bronze bearing and a pregreased and sealed rear ball race. We do not use the motor shaft as a spindle as the motor bearings are non-adjustable, and are therefore liable to 'chatter' and it normally operates at one speed only.

The unique feature of the Coronet lathe is the EXCLUSIVE SWIVELLING HEADSTOCK. The whole headstock unit, including the motor, may be swivelled through 180° and fixed in any position, allowing the operator to plane or saw long timbers in a confined space by directing the work past any obstruction or through a convenient door or window. This feature also allows for large diameter turning, on the face plate, up to 14" on the Minor and 23" on the Major. This extra capacity, which on most lathes is restricted by the height of centre above the lathe bed, is just one of the many advantages that these machines offer.

The Company's founder, Charles Parker, inventor and designer, was a man rich in ideas and principles, and thanks to his initial efforts we have today a large modern factory producing machines that are sold throughout the world markets. The Directors of Coronet Tool Company maintain the high standards set by the founder now deceased, and offer value for money backed by a good honest standard of workmanship. There are no light die castings used in the manufacture of our machines, our foundry casts in iron and high grade aluminium which is then machined by automatic and modern methods to achieve the desired standard of accuracy.

You will find throughout this brochure, working photographs and descriptions of the use of the attachments and accessories, and in the panel below is a small selection of these with the appropriate part numbers.

FOR PRICES AND POSTAL CHARGES REFER TO THE ENCLOSED PRICE LIST/ORDER FORM.

WHEN ORDERING. IT IS ESSENTIAL TO QUOTE PART NUMBERS AND MODEL.

INDEX

FOREWORD AND GENERAL INFORMATION	2
ATTACHMENTS AND FITMENTS FOR MINOR AND MINORETTE	3
MINOR AND MINORETTE	4
MAJOR AND MAJORETTE	5
CIRCULAR SAW TABLE	6
CIRCULAR SAW TABLE - FITMENTS	7
4½" PLANER	8
MORTISING ATTACHMENT AND COMBINATION TABLE	9
DISC SANDER	10
BELT SANDER	11
TURNING	12
LONG HOLE BORING	13
BANDSAWING	14
CIRCULAR SAW TABLE - FITMENTS	15
ACCESSORIES FOR TURNING, MORTISING, CIRCULAR SAWING	16
ACCESSORIES - GUARDS, MOTORS, SANDING REQUISITES	17
SWIVEL HEADSTOCK	18
HOME MADE JIGS	19

Part No. MINOR/ MINORETTE	DESCRIPTION OF PART	Part No. MAJOR/ MAJORETTE	Part No. MINOR/ MINORETTE	DESCRIPTION OF PART	Part No. MAJOR/ MAJORETTE
MI	Minorette and Majorette Basic	C.M.500A	M.137	Moulding block and insert (Standard cutters available 1-24, see separate list)	A.175
M.2 & M.3	Lathe complete with centres, faceplate and tool rests.	C.M.500			
M.5	Motor double ended shaft	C.M.501	M.137/1	Hold down springs to assist in spindle moulding	A.175/1
M.504B	Imp Bandsaw attachment	C.M.504B	M.8	Grindstone Arbor, to fit spindle nose	CM.512
A.27	Imp Bandsaw Blades	A.27	A.25	6" Grindstone, 60 grit	A.25
M.12	4½" Planing attachment	C.M.507	M.19	Speed reduction Countershaft with belt	CM.522
M.12A	Thickening attachment	C.M.507A	Minor	Long hole boring attachment, 1/8" or 3/8"	Major
M.508	6½" Sanding Plate (Minor) and 8" Sanding Plate (Major)	C.M.508	M.5A	Speed reducing gearbox, 4:1 reduction on motor speed	C.M.501A
M.520	8" Sanding Plate and Tilting Table with mitre fence	C.M.520	A.20	Geared drill chuck No. 1 morse taper shank	A.20
N/A	14" Sanding Plate and Tilting Table with mitre fence	C.M.520A	A.6	Friction type keyless chuck No. 1 morse taper shank	A.6
A.7	Sanding Discs 6½", 8" and 14" (state size)	A.7	M.503/4	4" Belt Sander attachment with abrasive belt complete	C.M.503/4
M.10A	Special Rest for M.520 and for large Turning	C.M.509A	N/A	6" Belt Sander attachment with abrasive belt complete	C.M.503/6
M.7	Patent Woodscrew Chuck, 1½" and 2½"	C.M.511A	A.8	Abrasive belts for above sanders	A.8
A.21	Set of six Sheffield Turning Tools	A.21	M.8/1	Grindstone guard and rest	C.M.512/1
A.1	Four Pronged Driving Centre (for small diameters)	A.1	M.517	Planer Belt guard	C.M.517
A.2	Cup Centre (used in conjunction with A.1)	A.2	M.516	Undersaw guard	C.M.516
A.3	90° Tailstock centre, general purpose	A.3	M.515	Main Belt guard	C.M.515
A.30	Two Pronged Driving Centre, general purpose	A.30	M.15	Mortising attachment adjustable stops in all directions	C.M.510A
A.11	Thread protector and centre ejector	A.11C.M.	S.M.5	Slot mortising bits, 1/8", 1/4", 3/8", 1/2", 5/8", 3/4", 1" (2" and 3")	S.M.5
A.10A	Revolving Centre	A.10A	N/A	Hollow square mortising chisels, 1/2", 5/8", 3/4" and 1"	A.5
A.17	Slip Stone	A.17	A.24	Mortising chuck, holds any tool with 1/2" shank	A.24C.M.
A.26	Wobble Saw and Insert, 7" and 8"	A.26C.M.	M.9	Combination table	C.M.519A
M.32	Combing Jig used with Wobble Saw	C.M.532	M.4	Tilting circular sawtable, riving knife and guard combination sawblade	C.M.502A
			MA.22	Circular saws, fine, medium and rip. 7" and 10"	A.22C.M.

ATTACHMENTS & FITMENTS FOR THE MINOR 10 in 1 & MINORETTE

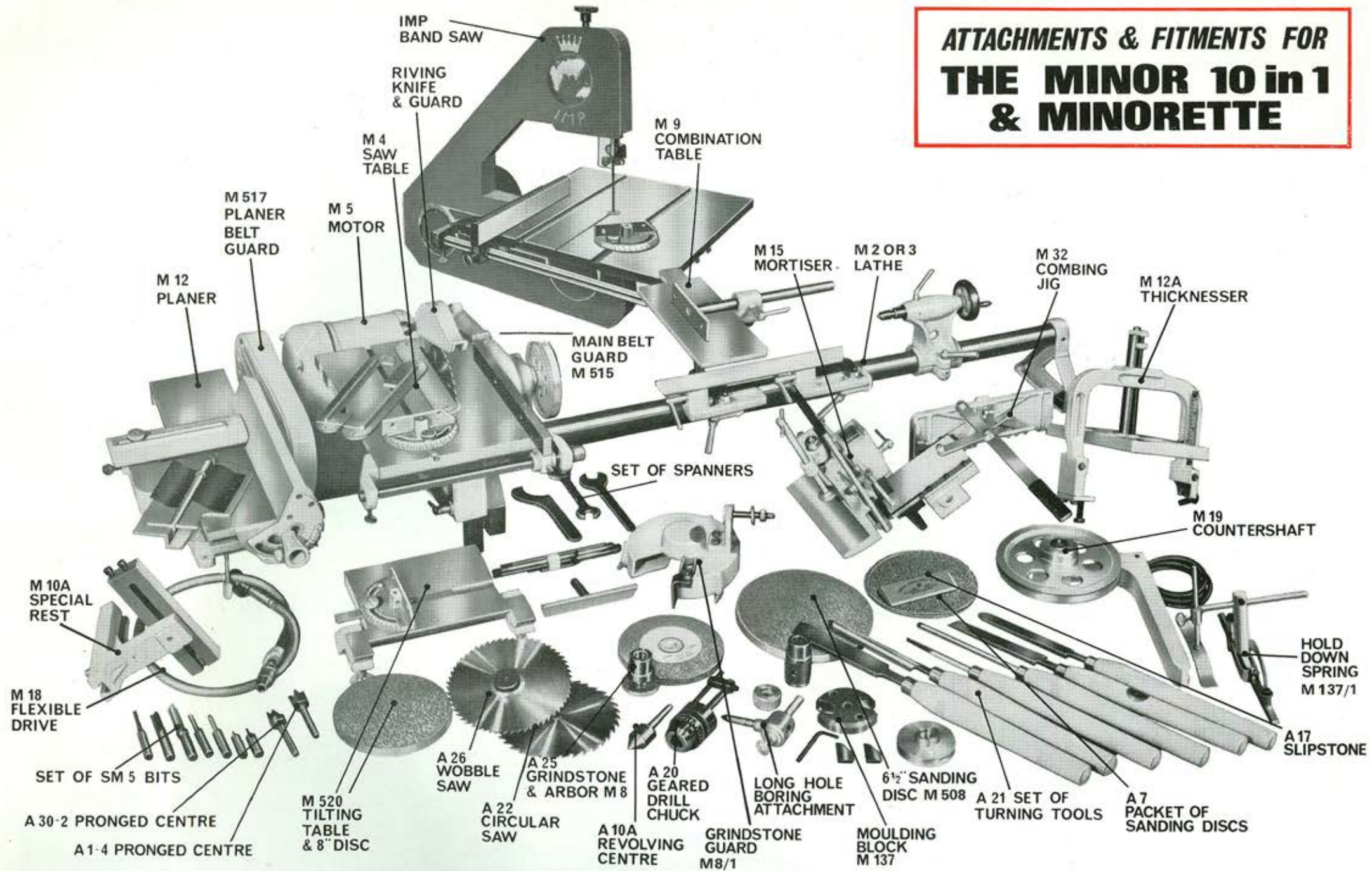

THE ABOVE ILLUSTRATIONS SHOW THE MINOR MACHINE WITH ATTACHMENTS AND FITMENTS. SIMILAR ATTACHMENTS AND FITMENTS ARE AVAILABLE FOR THE MAJOR MACHINES. WHEN ORDERING PLEASE REFER TO THE PRICE LIST/ORDER FORM WHICH SHOWS EQUIVALENT PART NUMBERS FOR THE MINORETTE, MAJOR AND MAJORETTE. FURTHER ILLUSTRATIONS OF FITMENTS WITH REFERENCE NUMBERS ARE FEATURED THROUGHOUT THIS BROCHURE.

THE CORONET TOOL COMPANY reserve the right, without prior notification, to vary, or amend the design, materials and method of manufacture, in development of all items in the range. All illustrations in this publication are the property of CORONET TOOL COMPANY and must not be reproduced in whole, or part, without written permission. Registered design and patent numbers, 85091, 878430, 886015 and 788318.



CORONET UNIVERSAL WOODWORKING MACHINES

MINOR

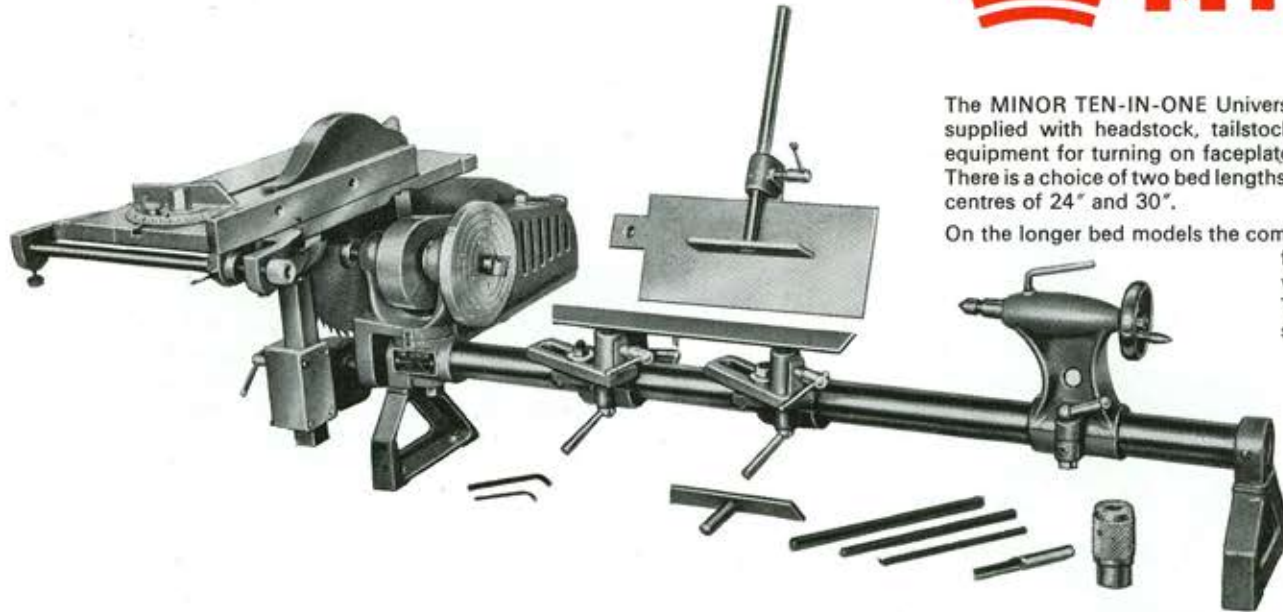

The MINOR TEN-IN-ONE Universal Woodworker is basically a Lathe, and is supplied with headstock, tailstock, faceplate and turning rests as standard equipment for turning on faceplate and between centres. There is a choice of two bed lengths, 3' 0" and 3' 6", giving distance in-between centres of 24" and 30".

On the longer bed models the combination table is movable a greater distance from the saw table to act as a panel support with adjustable fence for repetition cutting. The centre height is 3½" and headstock swivels for the turning of diameters of 14". Overall length of the 3' 0" bed model as illustrated is 4' 10".

Weight of Machine: 125 lbs.

The Machine can be supplied on attractive Cabinet Stand which has four holes for fixing to floor. It provides ample storage space and is complete with press-button starter and is ready for immediate connection to a power supply.



★ ALL MODELS SUPPLIED FOR BENCH MOUNTING OR ON CABINETS

MINORETTE



The MINORETTE is supplied as a Power Unit complete with Circular Saw, Motor, Belt and Pulleys, Combination Table, Grindstone and Arbor, Disc Sanding Plate, Slot Mortising Chuck and Slot Miller Bit, as illustrated.

Additional attachments may be added if and when required, such as Planer, Thicknesser, Sander (Belt and Disc), Bandsaw, Mortiser etc. The MINORETTE Power Unit is not equipped with turning facilities although this can be added (see separate list).

Overall length: 2' 3" Weight: 105 lbs.

The Machine can be supplied on attractive Cabinet Stand which has four holes for fixing to floor. It provides ample storage space, is complete with press-button starter and is ready for immediate connection to a power supply.



CORONET UNIVERSAL WOODWORKING MACHINES



MAJOR

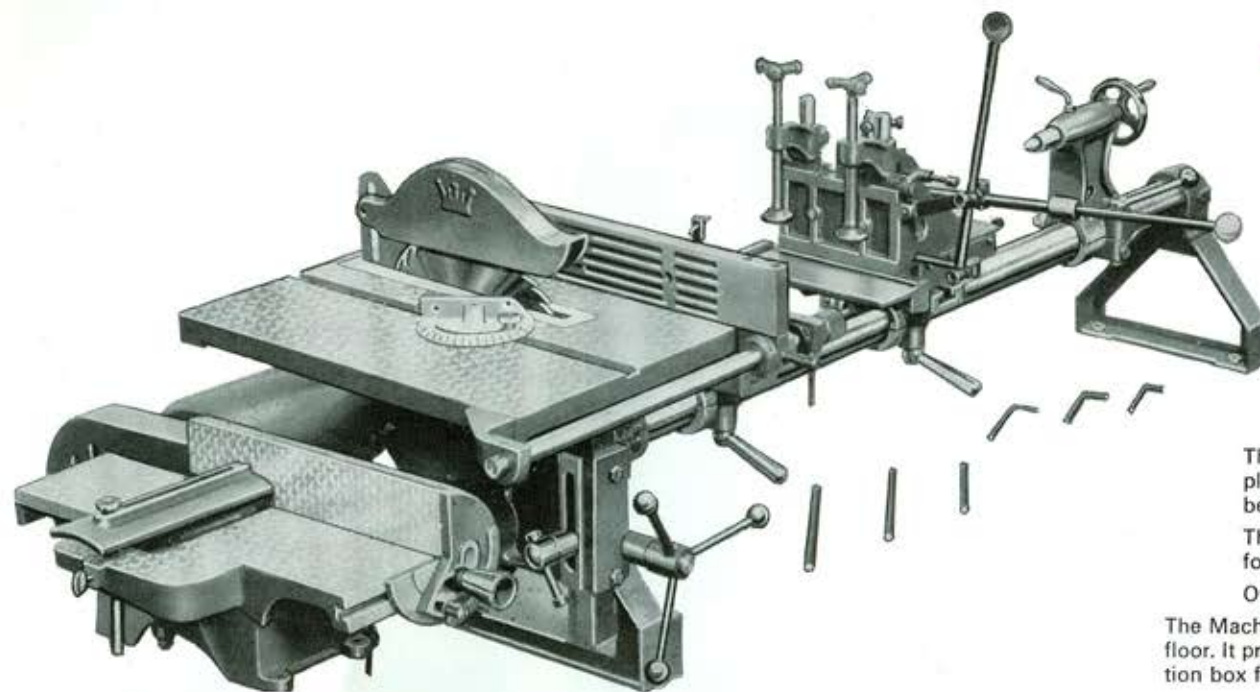

The MAJOR Universal Woodworking Machine is for trades requiring turnery in addition to general woodworking, planing, circular sawing, mortising, bandsawing, sanding, etc. Note the longer bed which is 48". This extra length allows the combination table to be moved a greater distance from the saw table to act as a panel support, with adjustable fence for repetition cutting.

This machine is provided with a tailstock, faceplate, and centres giving facilities for turning between centres 2' 9".

The centre height is 4½" and headstock swivels for the turning of diameters of 24".

Overall length : 5' 10". Weight of machine : 240 lbs.

The Machine can be supplied on attractive Cabinet Stand which has four holes for fixing to floor. It provides ample storage space and is complete with press-button starter and connection box for an immediate and simple method of fixing to a power supply.

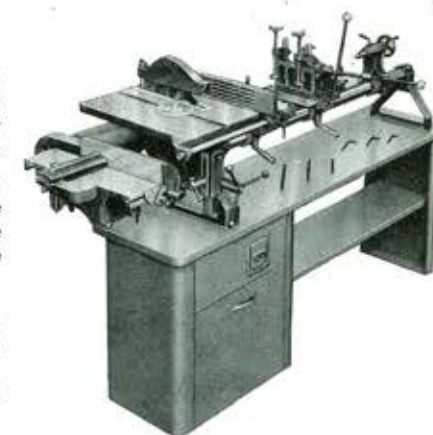

★ ALL MODELS SUPPLIED FOR BENCH MOUNTING OR ON CABINETS

MAJORETTE

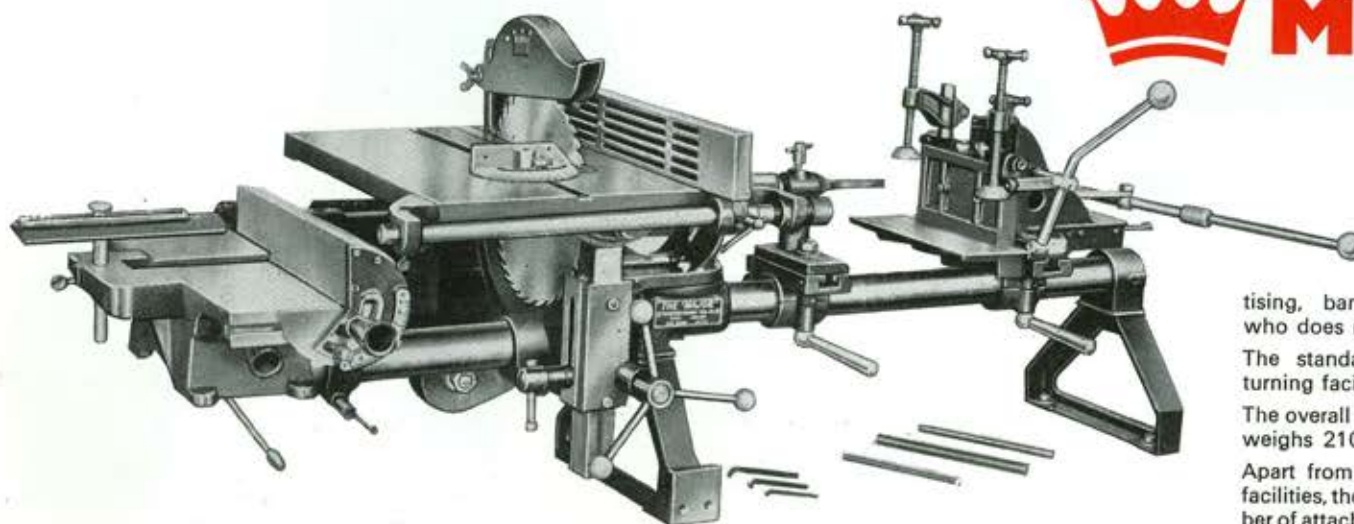

The MAJORETTE Universal Woodworking Machine is for anyone who requires to do general woodworking, planing, circular sawing, mortising, bandsawing, sanding, etc., and who does not require woodturning.

The standard bed is cut to 27" and turning facilities removed.

The overall length is 4' 2" and the machine weighs 210 lbs.

Apart from the removal of these turning facilities, the machine carries the same number of attachments as the MAJOR machine.

The Machine can be supplied on attractive Cabinet Stand which has four holes for fixing to floor. It provides ample storage space and is complete with press-button starter and connection box for an immediate and simple method of fixing to a power supply.



CIRCULAR SAW TABLE



CM 502A MAJOR CIRCULAR SAW TABLE.

10" circular saw – 3" depth of cut.
 Rise and fall by rack and pinion.
 Tilts 45° on graduated quadrant.
 Fence with rapid and micro adjustment.
 Mitre fence graduated 60° right and left.
 Riving knife and guard fitted.
 Accepts A175 Moulding block.
 A26CM Wobble saw.
 CM532 Combing jig.

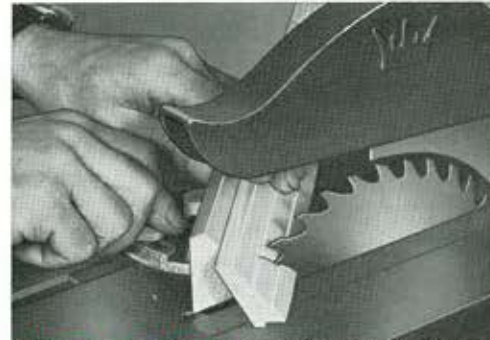

COMPOUND MITRES. Easily cut using bevelled strip fastened to mitre fence. Fence graduated to 60° either way.

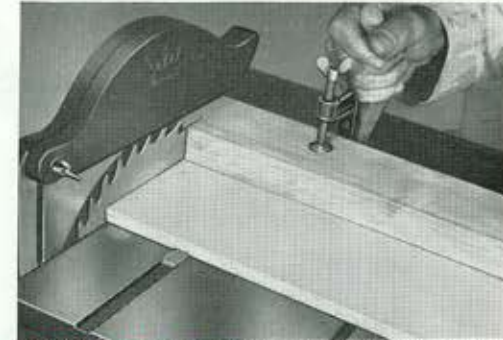

CROSS CUTTING JIG simplifies repetition cross cutting. Adjustable stop permits cutting of definite lengths.

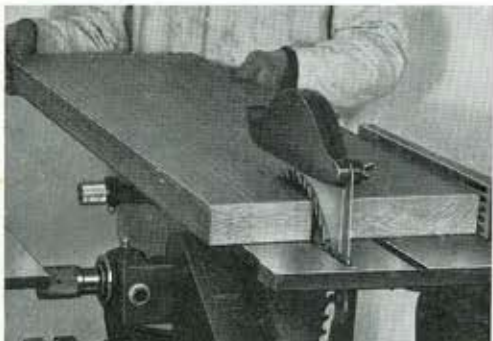

RIPSAWING 2" x 14" Oak board. Hard and softwoods handled with ease (see corner illustrations for capacities).



RIPSAWING with headstock swivelled to pass work along length of bed, utilising roller on rear of combination table fence. (Major Combination table only.)

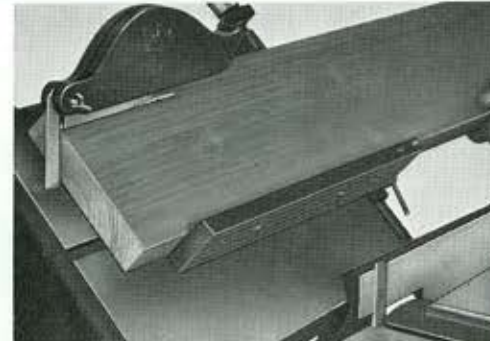

ANGLE SAWING up to 45° with table tilting on heavy graduated quadrant. Note guard and splitter (to prevent binding).



PANEL CUTTING using adjustable combination table. Capacity 9½" to 48". Note extension to fence of rebated timber to keep work steady.

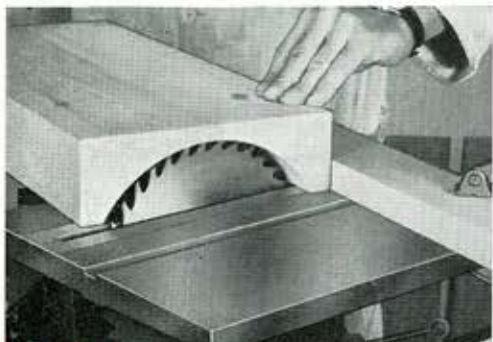

COVING with standard saw blade and wooden fence. Angle and placing of fence determines width and shape of cove. (Lower table approximately ½" per pass.)

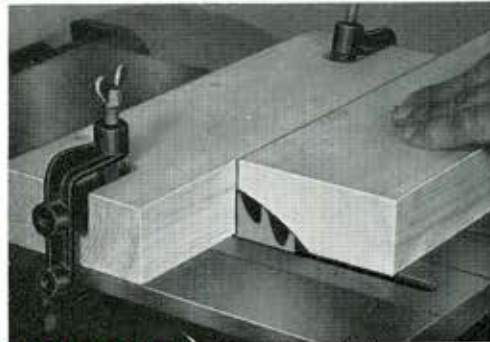

CORNER COVING. Using false wooden fence positioned to use portion of saw blade only. Increase cut by approximately ¼" each pass.

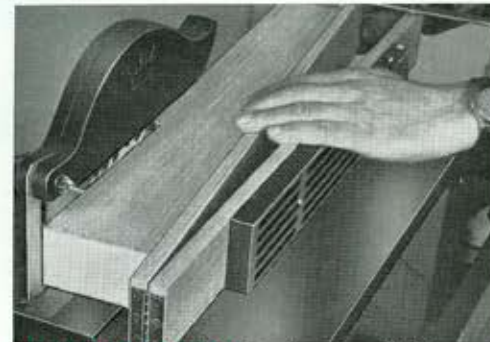

TAPERED RIP SAWING using simple hinged jig. Compound tapers can also be cut by tilting table. Useful when false cooping.

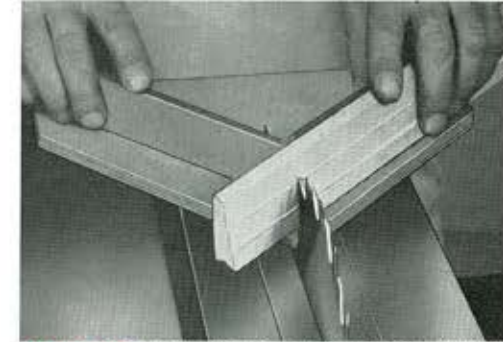

MITRE JIG most essential for accurate mitreing. Addition of bevelled strip permits compound angles to be cut.



CIRCLE CUTTING using simple jig clamped to saw table. Workpiece pivots on nail, or use adjustable jig as illustrated on circular sanding.

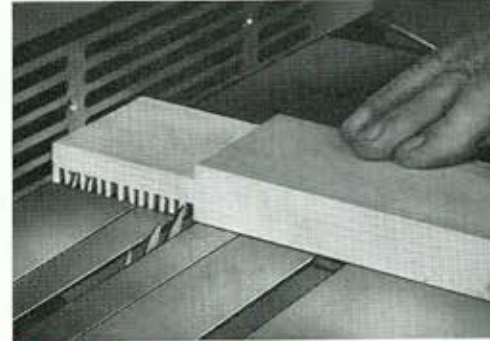

TENONING with series of cuts. Short ends break off easily, and finished with repeated cross movements. Thickened timbers ensure accuracy with this method.

M4. MINOR SAW TABLE.

7" circular saw – 2½" depth of cut.
 Rise and fall by manual adjustment.
 Tilts 45° on graduated quadrant.
 Fence with rapid and micro adjustment.
 Mitre fence graduated 60° right and left.
 Riving knife and guard fitted.
 Accepts A137 Moulding block.
 A26 Wobble saw.
 M32 Combing jig.

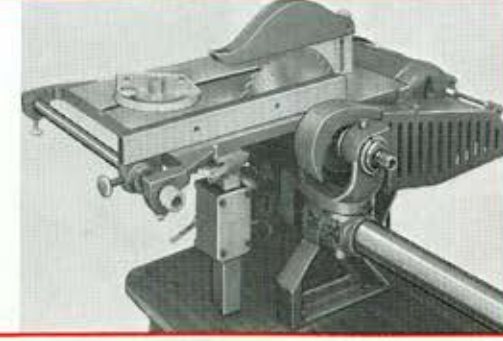

CIRCULAR SAW TABLE-FITMENTS

EXTRAS TO CM502A MAJOR SAW TABLE.
 A26CM 8" Wobble saw and insert, grooves from $\frac{1}{8}$ " to $\frac{7}{8}$ " wide by $2\frac{1}{4}$ " deep.
 M32 Combing jig used with above for comb jointing up to 1" thick timber.
 A175 Moulding block and insert accepts full range of cutters 1 - 24 (No. 15 requires special insert).
 A175/1 Hold down springs. Useful safety device, applies correct pressure when spindle moulding.



BOX COMBING. A 4" deep box accurately jointed in one minute. This operation normally takes hours by hand.

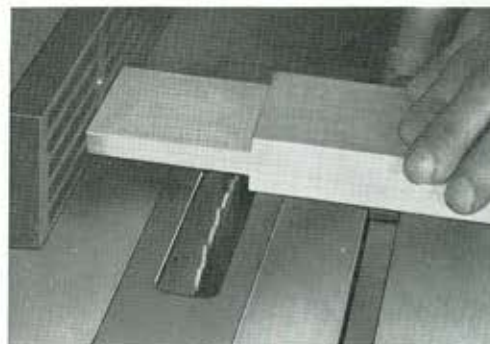

TENONING. Using Wobble saw and series of cuts. See tenoning with standard Rip Saw. Use fence for length. Set mitre fence to zero and cut with repeated cross movements.

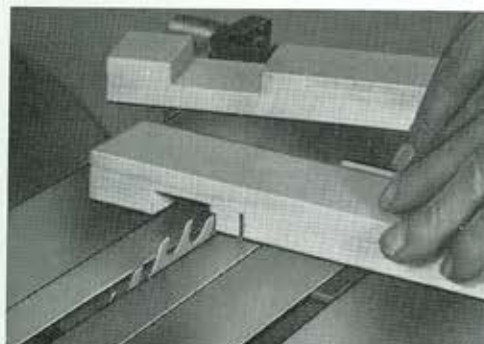

HALVING JOINTS can be cut using standard saw blade. Note mitre fence is used for correct angle. Work marked prior to cutting.

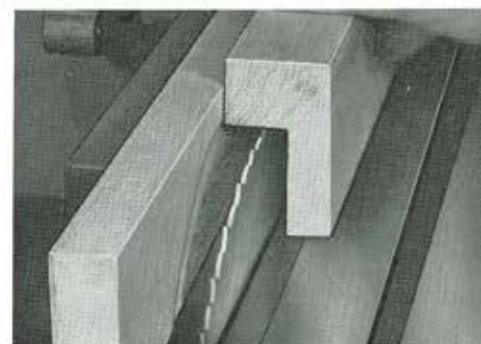

REBATING. Using false wooden fence to allow clean cut to edge of work. Wobble saw cuts up to $\frac{1}{2}$ " wide by 2" deep at one pass for speedy production.



GROOVING, with Wobble Saw permits grooves of $\frac{1}{4}$ " wide up to $\frac{3}{4}$ " to be machined at one pass.

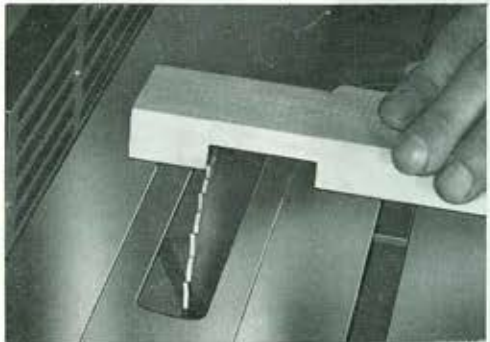

HALVING. Joints quickly cut using wobble saw in place of standard saw blade, using same method as in tenoning.

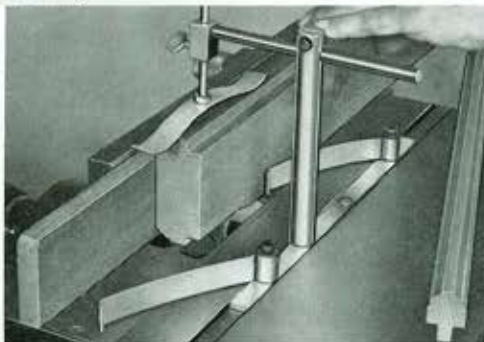

SPINDLE MOULDING using adjustable hold-down springs. See standard range of cutters available.

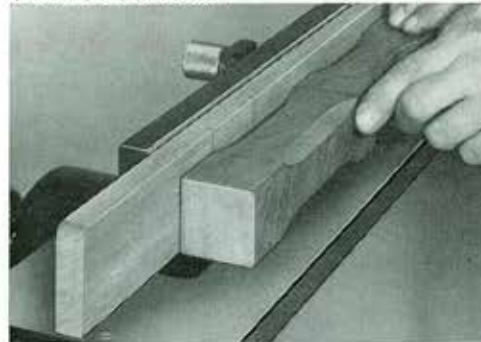

STOP CHAMFERING using No. 11 cutters. Mark work and wooden fence to length of chamfer. Pivot on front point of wood towards fence, then cut along to required length.

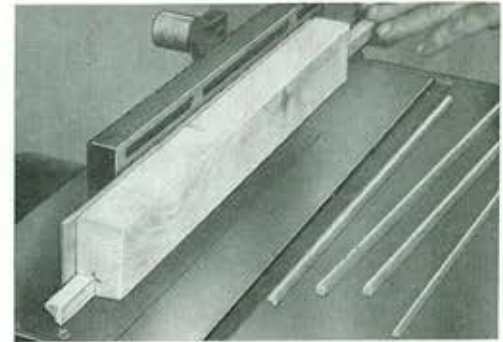

SMALL MOULDING produced with standard cutters but using improvised jig to suit dimensions of workpiece.

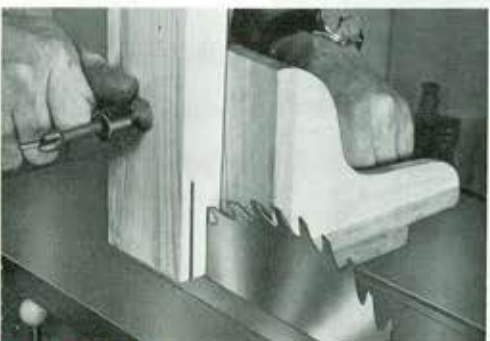

TENONING JIG being used with planed timber. Face side of work to jig ensures accuracy of tenon.

EXTRAS TO M4 MINOR SAW TABLE.
 A26 7" Wobble saw and insert grooves from $\frac{1}{8}$ " to $\frac{3}{4}$ " wide by 2" deep.
 M32 Combing jig used with above for comb jointing up to 1" thick timbers.
 M137 Moulding block and insert, accepts cutters Nos. 1 - 12 only.
 M137/1 Hold down springs. Useful safety device, applies correct pressure when spindle moulding.

4½" PLANER



CM 507 MAJOR and M 12 MINOR PLANER. 4½" wide by 17¾" overall length. Rebates from 0" - ½" deep. Graduated fence tilts 45° each way. Cutter speed - 6000 R.P.M. Blades (two) each fitted with 2 micro adjusting screws. Fully adjustable blade guard included.

CM 507A MAJOR and M 12A MINOR THICKNESSER. This attachment accepts timbers of up to 4" thick by 7" wide and is used with the above planer (see corner illustration).

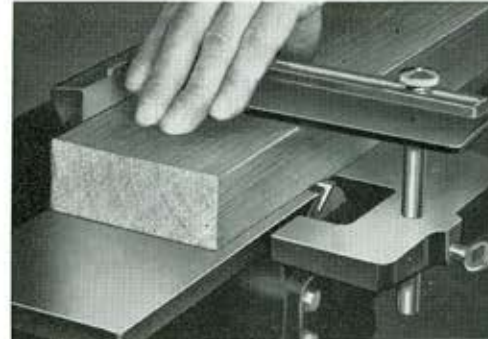

SURFACE PLANING 4" x 2" timber. Hardwood and softwoods handled with equal ease. Cutter speed of 6,000 R.P.M. ensures ripple-free finish.



ANGLE PLANING of thick timber being carried out using graduated tilting fence. Tilt to right for thick timber.

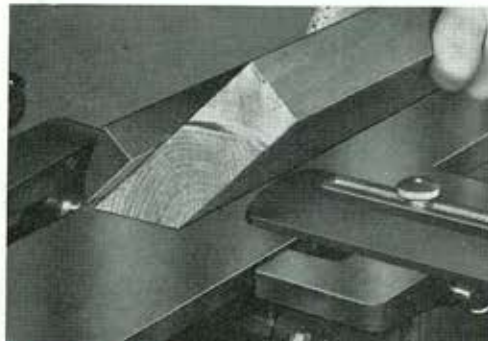

ANGLE PLANING of thinner, wider timber using graduated fence tilted to left. Accuracy is ensured when using this method.

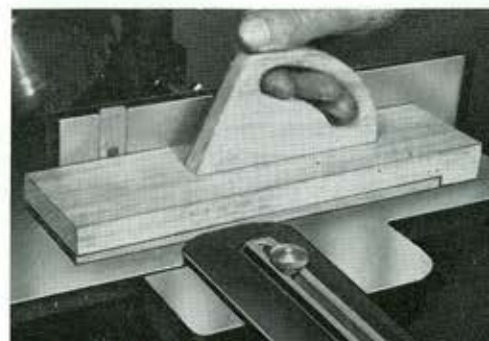

SURFACE PLANING JIG being used for thin, short timber. Accuracy and safety are combined with this jig. This is a 'must'.

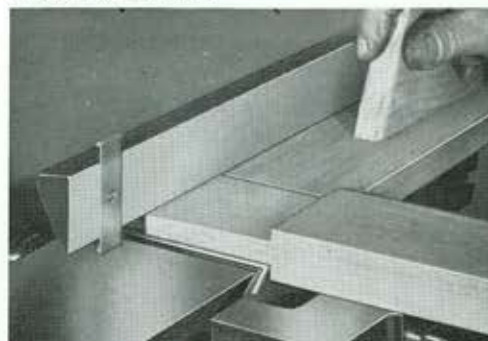

PLANING TENONS A ½" tenon being machined. Notice use of pusher block or scrap timber to maintain even pressure and to prevent splching.

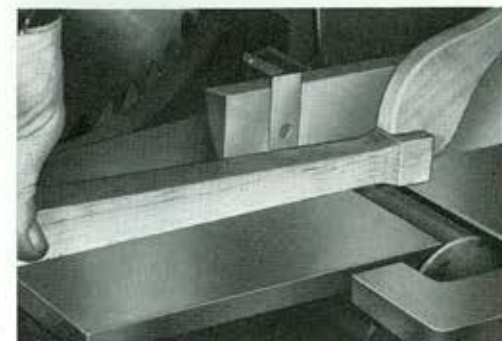

TAPER PLANING of chair leg or similar article is worked from parallel, and tapers of 7/10" per foot can be cut at one pass. Use push stick.

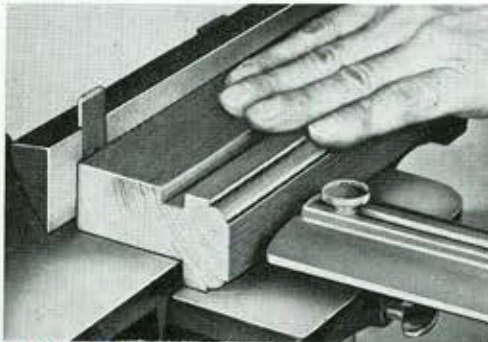

REBATING wide timber after spindle moulding with number 15 cutters. Surplus timber removed in one or more passes.

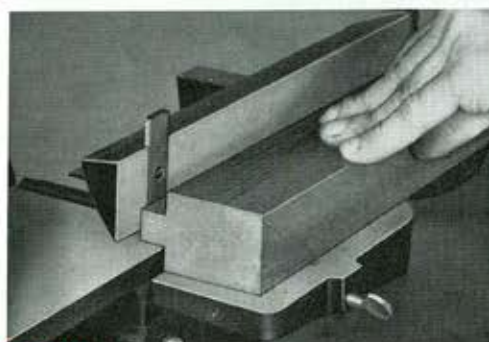

REBATES up to ½" deep are quickly machined. Front table is easily adjustable for this operation.

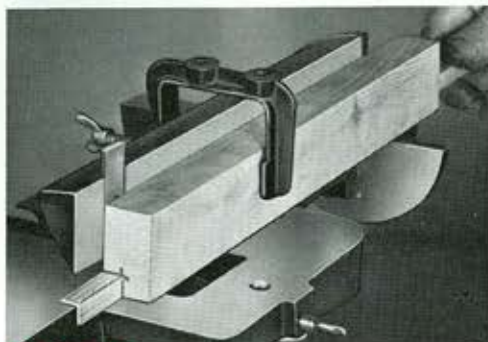

REBATING JIG for small section work is necessary. Sections quickly and safely machined using this method.

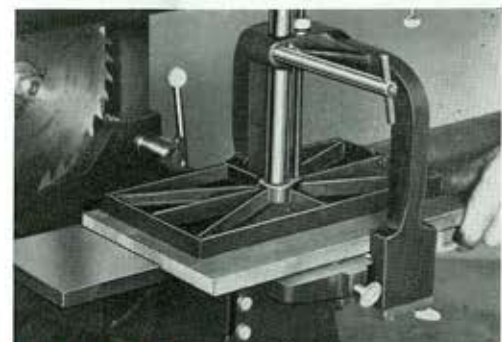

THICKNESSING timber up to 7" wide is possible, by taking two cuts, but it is essential that wood is not twisted before machining. Capacity 1/32" - 4".

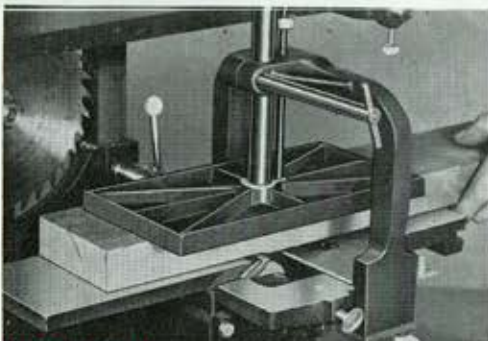

THICKNESSING of timber up to 4" thick is quick and accurate. Essential for producing timber of even thickness for jointing.



THICKNESSER ensures flat even joints of wafer thickness for laminating or veneering. Fine adjustment ensures accuracy.

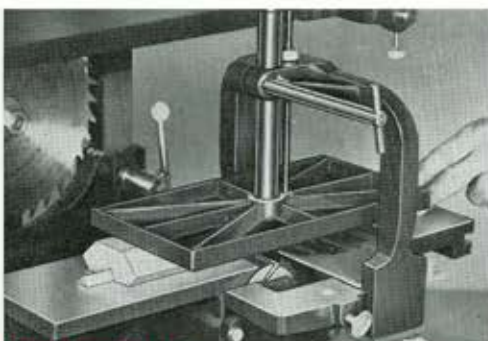

THICKNESSING JIG being used to produce section other than flat. This method only limited by personal ingenuity.



THICKNESS ATTACHMENT. Shown in position on planer.

MORTISING ATTACHMENT & COMBINATION TABLE

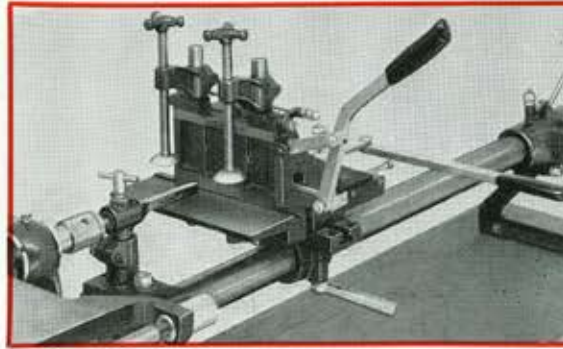

CM 510A MAJOR MORTISER. Accepts timbers of up to 6" thick. 5" movement in all directions with length and depth stops. Horizontal and longitudinal feed by compound levers. Hollow square chisels $\frac{1}{4}$ ", $\frac{5}{16}$ ", $\frac{3}{8}$ ", $\frac{1}{2}$ ". Slot miller bits $\frac{1}{8}$ ", $\frac{3}{16}$ ", $\frac{1}{4}$ ", $\frac{5}{16}$ ", $\frac{3}{8}$ ", $\frac{1}{2}$ ", $\frac{5}{8}$ ", $\frac{3}{4}$ ", $\frac{7}{8}$ ".

M15 MINOR MORTISER (below) Similar to above but for use with slot miller bits only $\frac{1}{8}$ " to $\frac{3}{8}$ ", accepts timber up to 4" thick.



C.M. 519A COMBINATION TABLE. Infinite variable height, used for slot mortising, grooving, panel cutting, roller take-off sanding and boring, etc.



SLOT MORTISING using combination table. Easily adjustable height and rigid fence makes light work of mortises up to $\frac{1}{2}$ " wide.

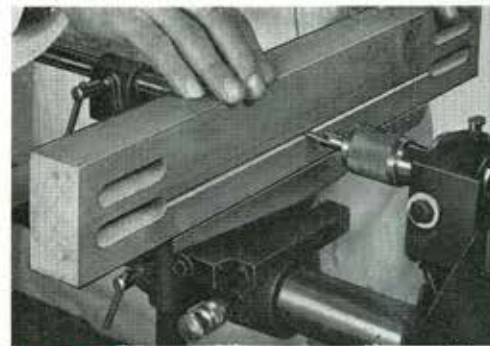

SLOTTING between mortises or tenons. After mortising, merely replace cutter. Height remains constant. Rapid method of grooving. Ideal method for letting in panels.



CUTTING CIRCLES with small slot mortise cutter and simple wooden jig mounted on combination table, or mortising attachment. Pivot work on nail.

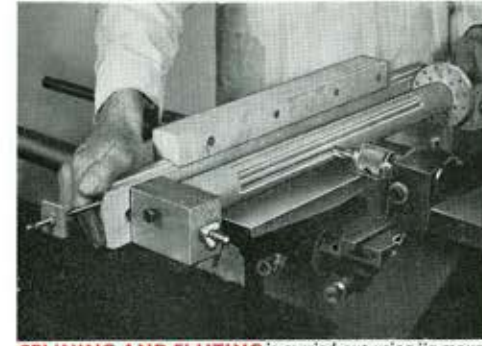

SPLINING AND FLUTING is carried out using jig mounted on combination table, or mortising table (using positive stops). Index plate is drilled for various number of flutes. (See Plans on page 19).

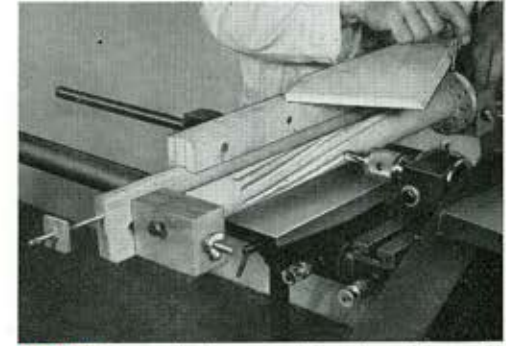

TWISTS are machined on same jig as for splining, with modifications. Twist is determined by rod in edge of index plate, bearing on angled plate. (See Plans on page 19).

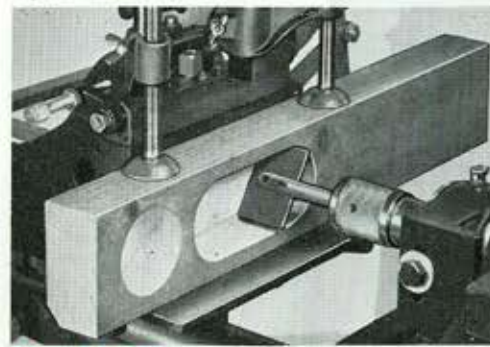

LARGE CUTTER made from $\frac{1}{2}$ " gauge plate fastened to $\frac{1}{2}$ " diameter bar show power availability of machine. Various shapes can be used according to need.

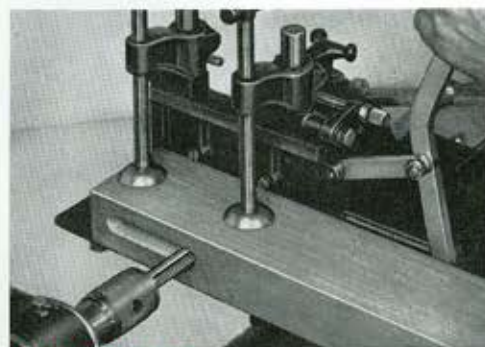

SLOT MORTISING on the mortising attachment has the advantage of adjustable stops on all sides. Useful for the heavier timbers. Cutters up to $\frac{3}{4}$ ".

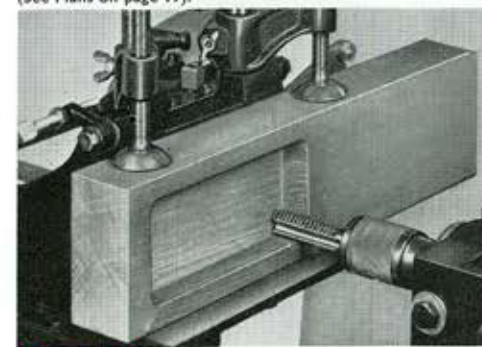

MORTISING attachment being used for routing large rectangular holes. Rise and fall movement and adequate stop permits large scope in this field.

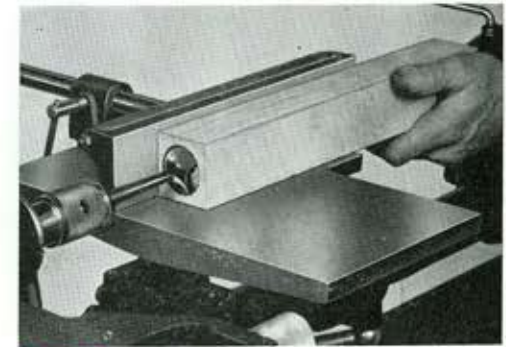

BORING on combination table, using fence set in alternate position as illustrated. For large diameters, lip and spur drills are best.

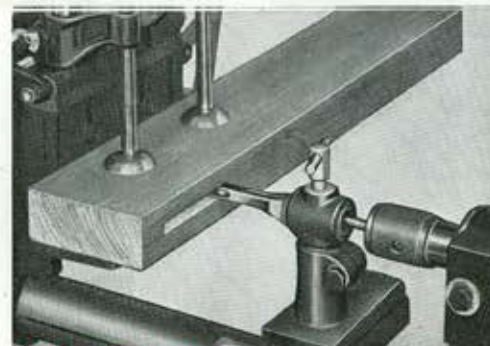

SQUARE MORTISING using hollow square chisel. Cutters available from $\frac{1}{2}$ " to $\frac{1}{2}$ " square. Lever feed permits comparative ease of movement. Adjustable stop on all slides.

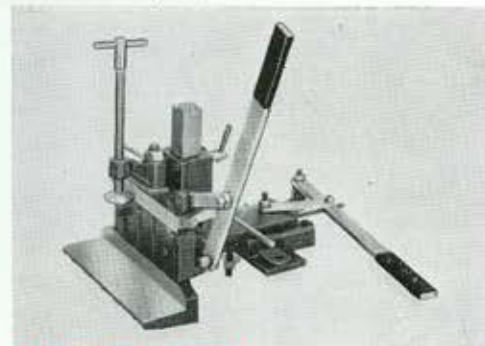

M.15 MINOR MORTISER for slot mortising. Rise and fall manually. Cross and longitudinal feed by compound levers. Adequate stops in all directions. Accepts timber, 4" x 4"

CM 519A MAJOR COMBINATION TABLE (see above). Infinitely variable height with adjustable fence on sliding bar. Used for slot mortising (in place of mortising attachment), grooving, sanding, boring, etc., panel cutting as extension to saw table or for ripping using roller take-off with headstock swivelled 90°.

M9 MINOR COMBINATION TABLE. Similar to above but without roller take-off.

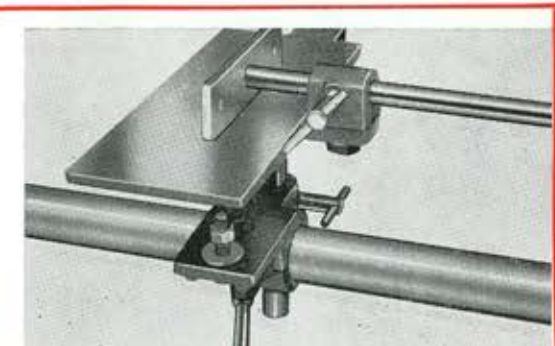

DISC SANDER

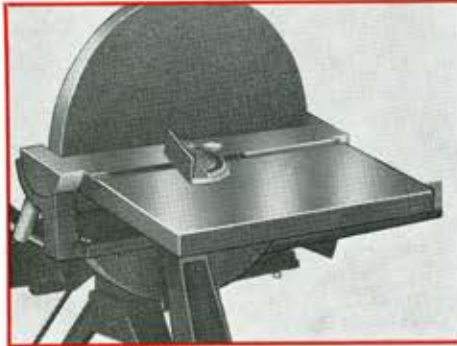

CM520A MAJOR DISC SANDER ATTACHMENT. 14" diameter disc sander with tilting table and mitre fence graduated 45° right and left. Mounted as for large diameter bowl turning (headstock swivelled 90°). Used in conjunction with CM509A special rest.

CM520 MAJOR DISC SANDER ATTACHMENT. 8" diameter, similar to above but can be used directly over bed without swivelling headstock.



CIRCLE SANDING using jig mounted on combination table. Adjustable centre pin on strip controls diameter. Fence of table removed and jig bolted through existing hole.

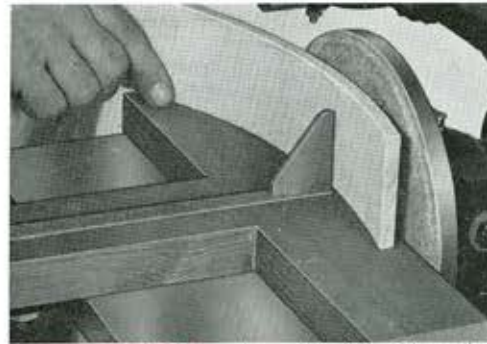

CURVED SECTIONS can be sanded, using circle sanding jig mounted on combination table. The sliding strip with pin is replaced with stop as shown.

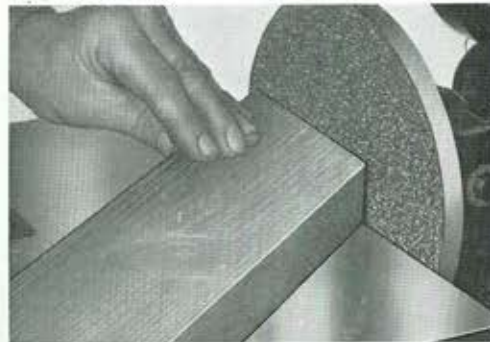

SANDING square or irregular shapes can be carried out using 8" disc with combination table. Fence removed to give freedom of movement.



STANDARD SANDING table being used with mitre fence to accurately square the ends of timber. Mitre fence can be set for angles up to 60°.

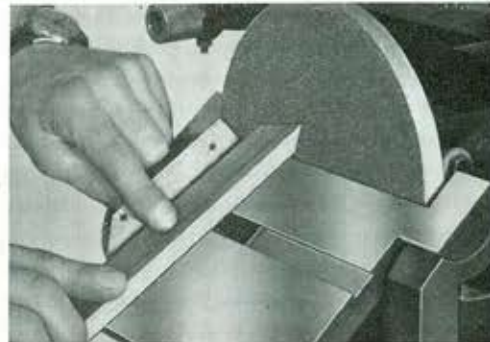

STANDARD SANDING table being used in tilted position to sand compound angle. Mitre fence controls angle.

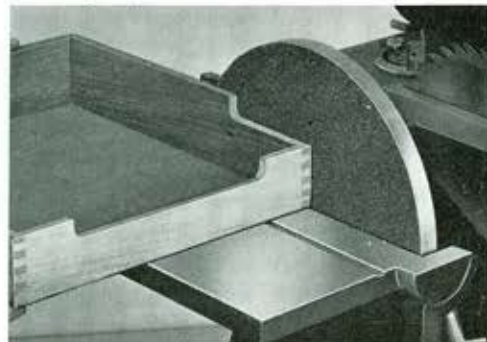

LARGE DRAWER being sanded with 14" disc and adjustable cable. Head of machine swivelled for this operation.

DISC SANDERS

Both the amateur and professional woodworker find sanding discs and belts invaluable tools for removing stock, shaping, sizing and finishing wood.

The method illustrated here for utilising the sanders to their full advantage can be modified to suit any particular job. On the 8" and 14" disc sanders with tilting tables, even the most-complicated compound angles can be sanded. These are useful for pattern makers and others who are working to fine limits.

BELT SANDERS (OPPOSITE PAGE)

The belt sanders in 4" and 6" width are also a useful tool for sanding with the grain to obtain the finest finish possible. These are fitted with an adjustable fence which will tilt through 45°.

The illustrations of the home made belt sander are self explanatory. A very versatile sander can be made by the individual on the pattern of these illustrations.

Drawings available at 5/-. Bearing and metal fittings extra.

The bobbin sanders are merely turned pieces of wood, mounted on a wood-screw chuck, and are covered with abrasive paper which is stuck on with contact adhesive.

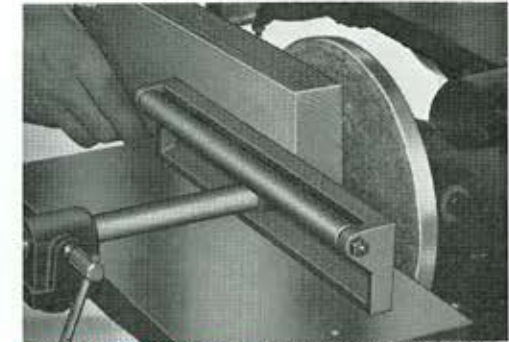

THICKNESS SANDING using combination table fence as pressure pad. High degree of accuracy is obtained using this method.

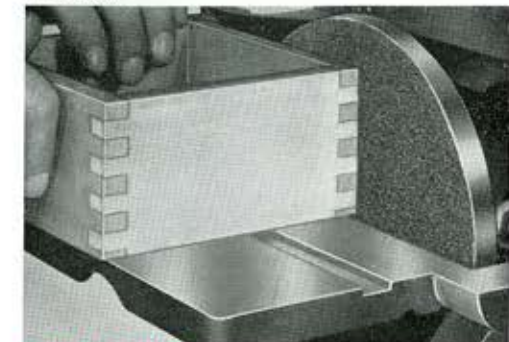

FINISH SANDING of 4" deep combed box. Using 8" disc with standard sanding table.



RADIUSING TENONS, using disc sander. Tenons sanded to suit radius of slot mortice cutter. Quicker than squaring the ends of the mortise.

M 520 MINOR DISC SANDER ATTACHMENT. 8" diameter disc sander with tilting table and mitre fence graduated 45° right and left. Mounted as for large bowl turning (headstock swivelled 90°). Used in conjunction with M10A special rest.

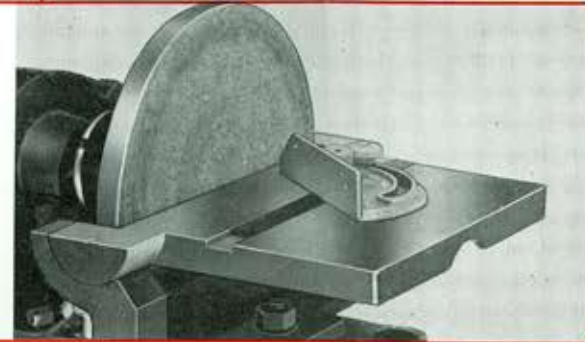

BELT SANDER

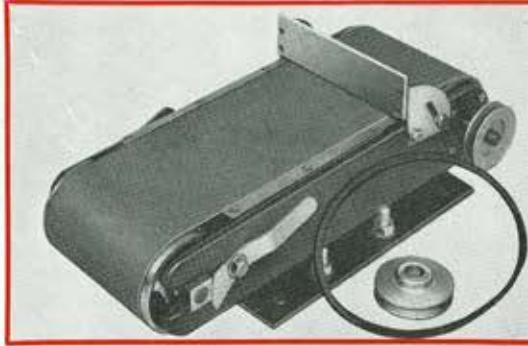

CM503/4" MAJOR BELT SANDING ATTACHMENT. 36" x 4" abrasive belt, adjusted for alignment by cam action. Steel rollers with sealed ball bearing races require no attention and ensure long life. Supplied complete with headstock pulley, V belt, abrasive band and removable fence, adjustable from 0° - 45°.

CM503/6" MAJOR BELT SANDING ATTACHMENT. Similar to above but with 43" by 6" wide belts.

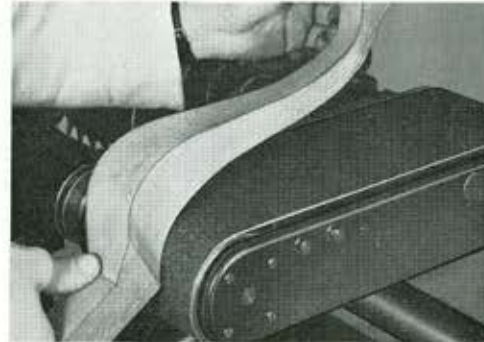

BELT SANDER is available in two sizes 4" and 6" wide. Solidly constructed and easily mounted. Gives smooth finish without imperfections.



FLAT SANDING is ensured by 1/2" thick steel table. Complete rigidity of sander permits accurate work. Ample tracking and belt tensioning.



BEVELS AND RADIUS are easily sanded by tilting work on sander. Wide scope for freehand work.



ADJUSTABLE FENCE permits sanding of end grain. Work can be passed across fence to ensure first class finish.



ANGULAR SANDING is carried out by tilting the adjustable fence, which is locked on both sides for stability.

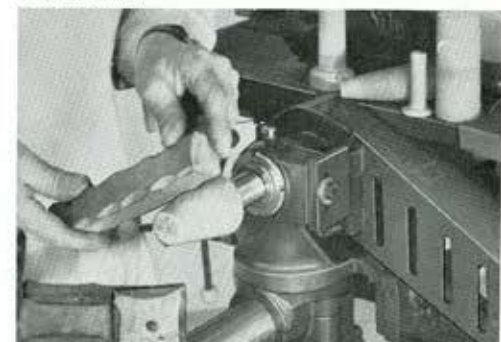

BOBBIN SANDERS of turned wood, with abrasive paper stuck on are useful for small radii. For rapid remounting, use woodscrew chuck.



FOOT of cabriole leg sanded on home made bobbins, which is turned on a woodscrew chuck to suit radius to be worked.



HOME MADE belt sander is versatile. Here, sanding belt is threaded through handle to finish sanding.



FLEXIBILITY of home made sander is demonstrated sanding a large radius. Note driving bobbin is mounted on woodscrew chuck.

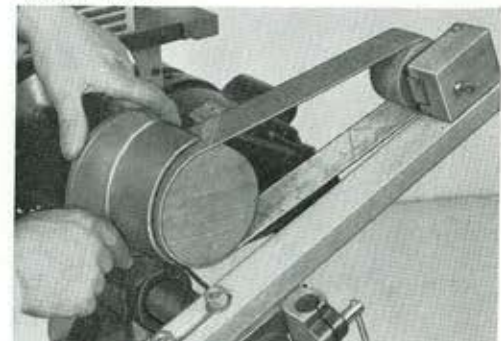

INTERNAL SANDING using diameter of bobbin to suit radius, plus length of sanding belt for long life.



ARC OF CONTACT is controlled by tensioning belt. Tracker box ensures true alignment.

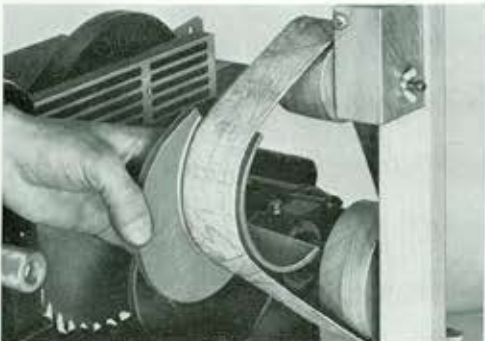

REVERSING sanding belt to sand outside of large radius. The extreme versatility is ably demonstrated.

M503/4" MINOR BELT SANDING ATTACHMENT. Similar model to the Major 4" (see top left hand corner).

These sanding attachments are fitted to the saddle nearest the headstock with the pulley screwed onto the spindle nose. The V belt is tensioned by adjusting the position of the sander on the saddle.

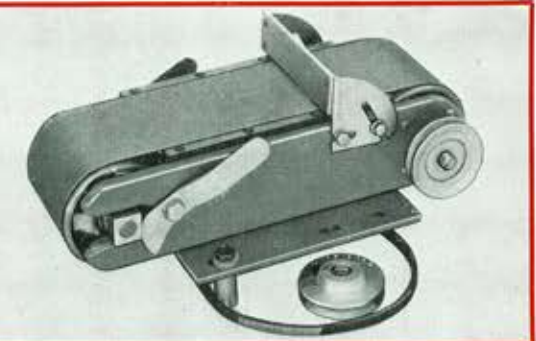

TURNING

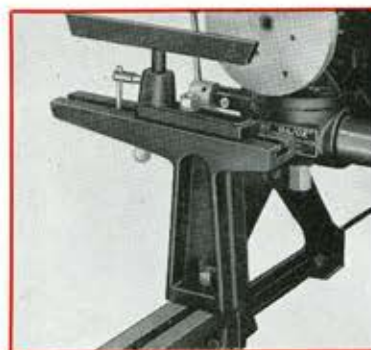

CM 509A MAJOR SPECIAL REST. This attachment is used for large diameter disc and bowl turning up to 24". Of heavy construction throughout in high density cast iron giving complete rigidity. Adjustable from 1½" to 8" from face plate.

M 10A MINOR SPECIAL REST. Similar to above with maximum capacity of 14". Manufactured to same high quality. Adjustable from 0" to 5½" from faceplate. The above rests are used in conjunction with Disc Sanders shown on previous page.



LARGE BOWLS can be turned, by swivelling the headstock and fitting the large turning rest, capacity of 14" on Minor and 23" on Major.

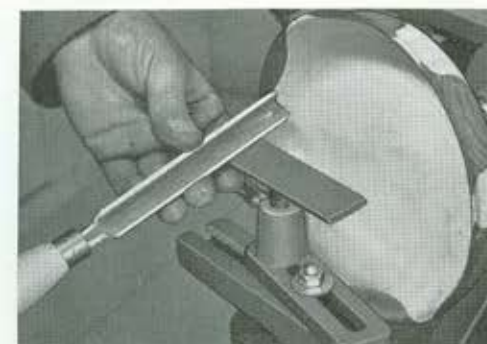

LAMINATED BOWL being produced on a Minor lathe. Maximum diameter permitted 14".



SMALL ORNAMENTAL bowl in walnut, with inserts of sycamore. Many deviations of this idea can be used by the turner.

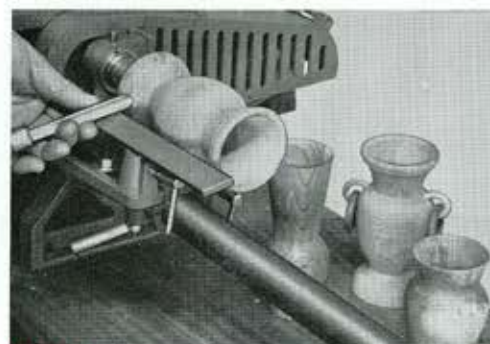

VASES and other deep bored turnery is best mounted on the large woodscrew chuck and secured with two additional screws.



COOPERING is a method where timbers can be joined to make large hollow vessels. Illustrated are some examples.



EGG CUPS and similar articles are best turned on a small woodscrew chuck. This affords rigidity with economy of timber.



SERVIETTE RINGS and curtain rings are best turned on a spigot after first boring and parting off the pieces.

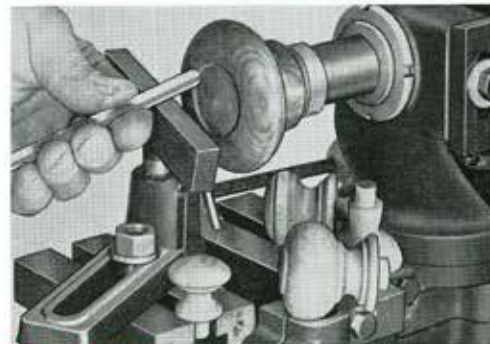

DOOR KNOBS and drawer knobs are easily produced using the woodscrew chuck for mounting on lathe.

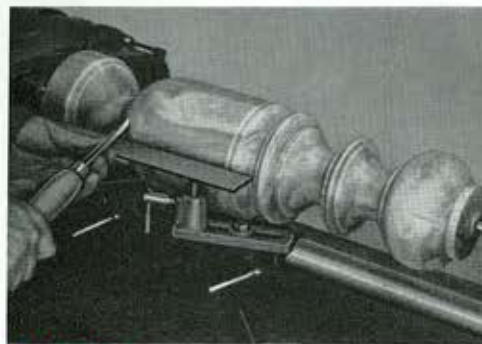

BALUSTERS and similar turnery is produced by mounting work between centres. A revolving centre will prevent ends of wood burning.

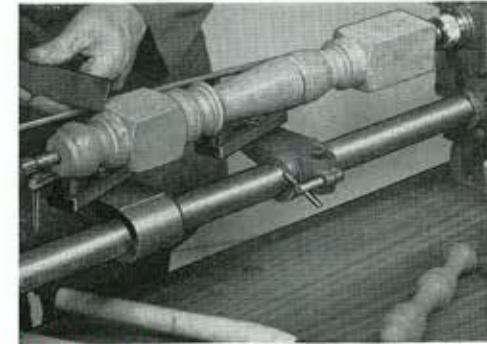
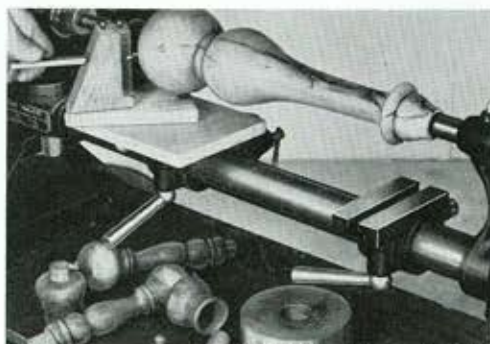

TABLE LEGS can be produced from the square as illustrated. Length of 24" on Minor or 33" on Major.



TABLE LAMPS easily turned between standard centres. Wide scope for the artistic turner.



SPHERICAL TURNING jig being used to produce true sphere on chandelier centre piece. Another easily made jig.

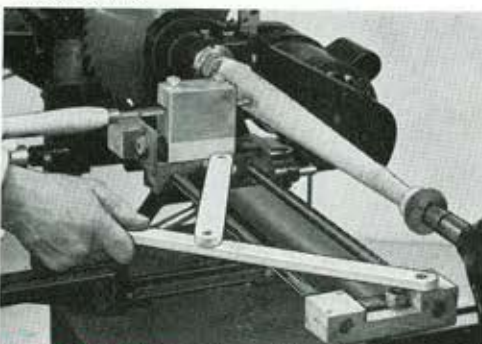

TAPER TURNING and parallel turning is accurately repeated using the illustrated jig.

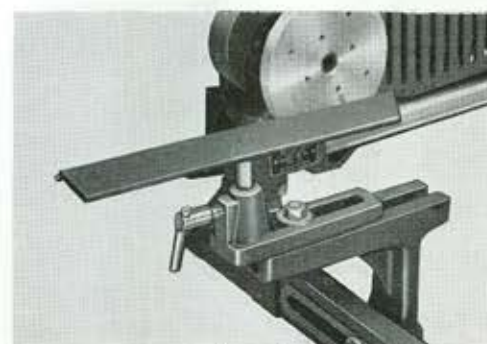

M10A SPECIAL REST shown in position on Minor.

LONG HOLE BORING

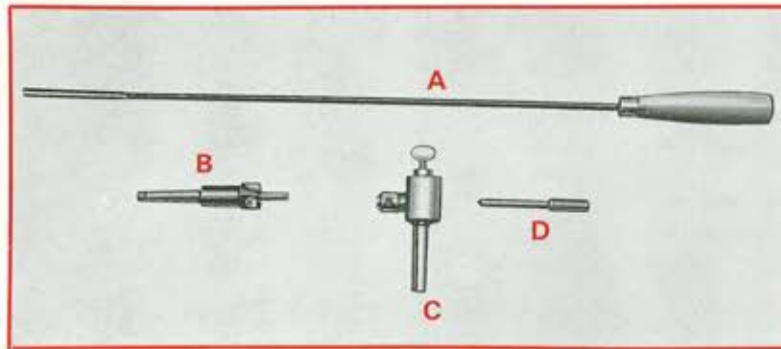

5/16" LONG HOLE BORING KIT

Comprising 5/16" x 24" drill, Counter-bore tool jig and centre finder.

- A Long Hole Boring Drill 5/16"
- B Counter Bore Tool with Pilot.
- C Drilling Jig and Bush, 1/2" Shank Minor 5/8" Major
- D Centre Finder.



LONG HOLE BORING through body of chandelier, 5/16" dia. drill for standard electric fittings (Pillar Nipples)

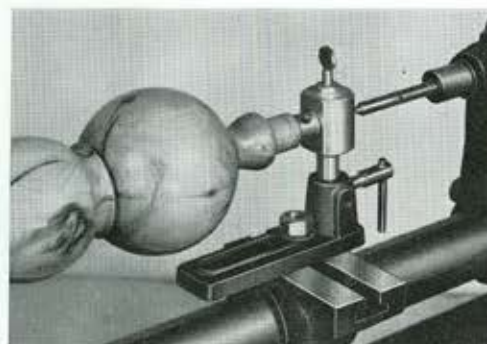

HOLLOW CENTRE of boring jig shown in detail. Long centre passes through jig and into centre of work for perfect alignment.



COUNTERBORE tool being used to bore for plug of capping.

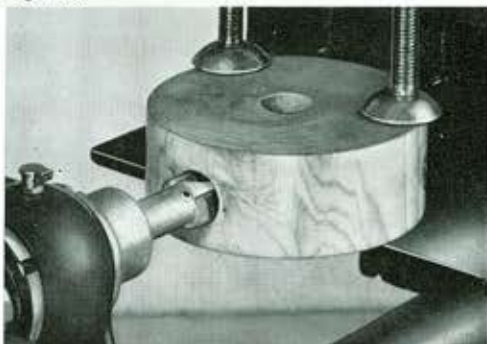

MORTISING attachment used to hold hub of chandelier whilst drilling with counterbore tool for arm.

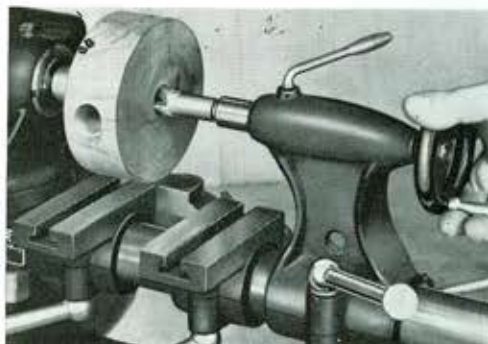

COUNTERBORE tools used in tailstock to produce hole in hub of chandelier.

LONG HOLE BORING ATTACHMENT.

The Long Hole Boring Attachment is designed to drill clean holes for passing through wire for the electrical fitting. The 3/16" drill supplied is the correct size to permit the fitting of the screwed adaptor (Pillar Nipple) that accepts the light fitting. The illustration on this page shows the boring tool and counterbore in use. When using the boring tool, depth of each pass should not exceed 1" - 1 1/2", and the drill should be removed and the chips shaken clear. This prevents the drill from binding.

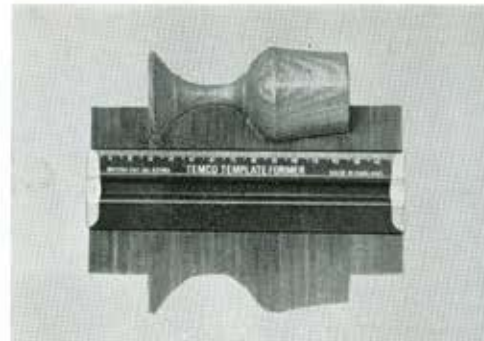

An ideal use of the Former for wood-turners is to use it as a template for repetition turning.

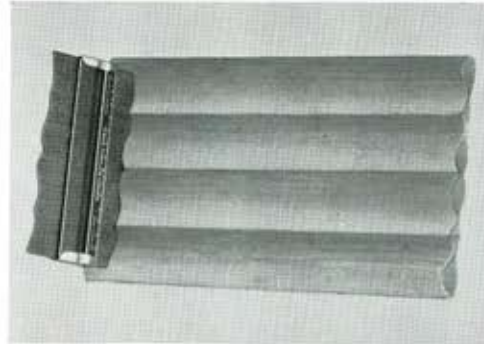

The Temco Template Former will quickly produce male or female profiles suitable for marking out the mating shapes.

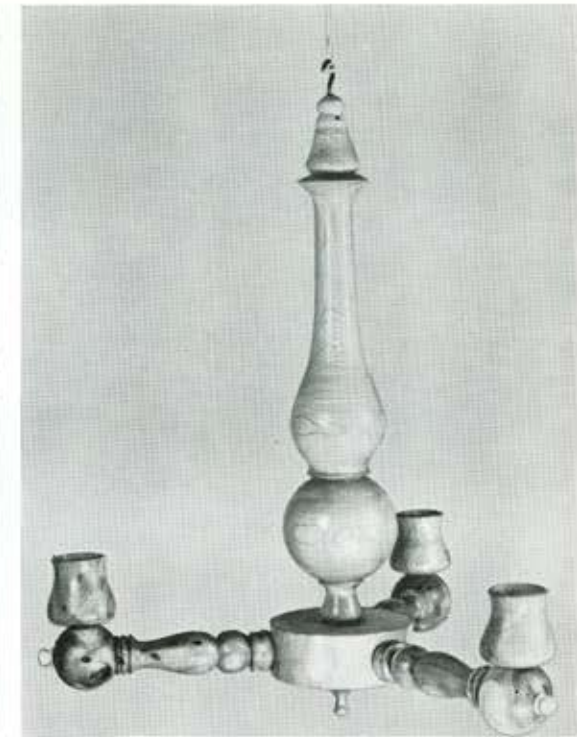

CHANDELIER completed in yew, each arm is bored for wire and small plugs inserted to finish off.

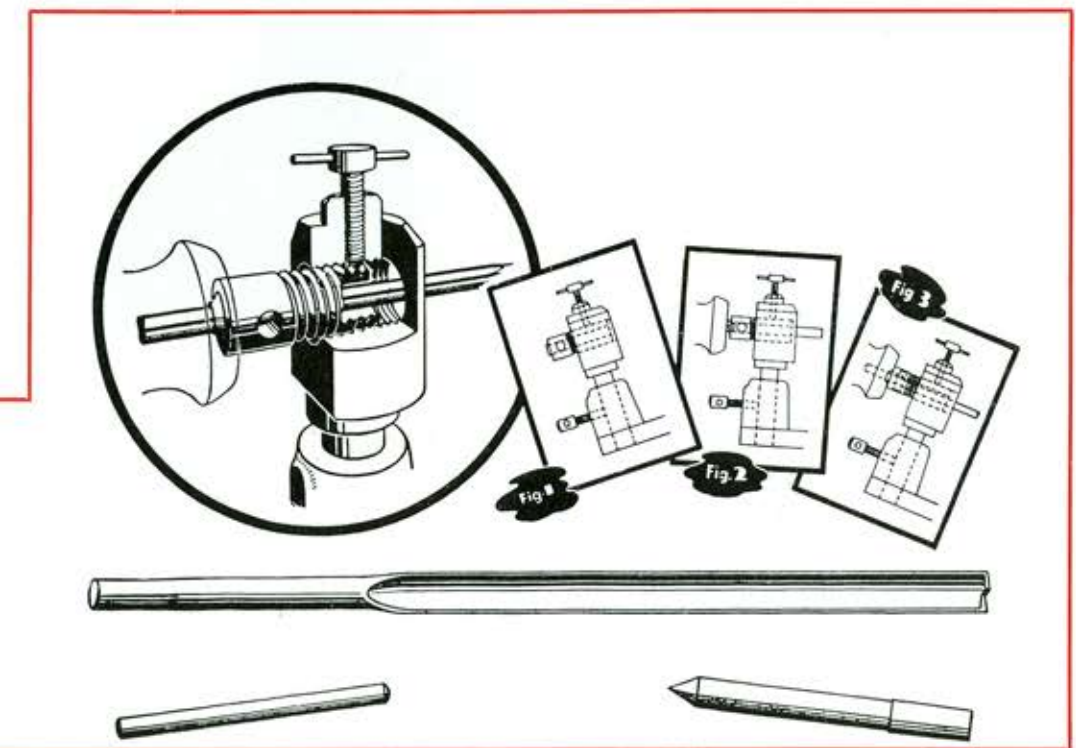

BANDSAWING

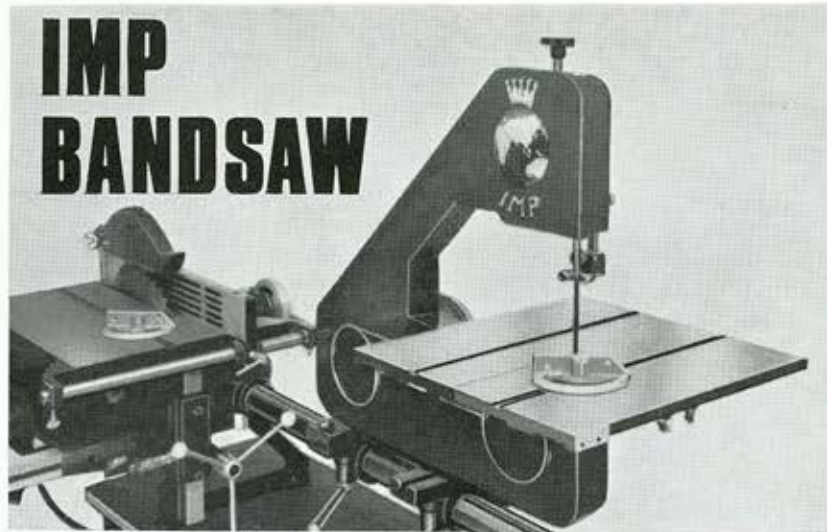

**FOR STEEL,
NON-FERROUS
AND PLASTICS**

1" 14, 24
 1 1/2" 14, 24
 2" 14, T.P.I.

**FOR HARD AND
SOFTWOODS**

1/2" 6 T.P.I.
 3/4" 3-6 T.P.I.
 1" 3-6 T.P.I.

**BLADES FOR SPECIAL
MATERIALS, TEXTILES,
FOAM RUBBER,
LEATHER, PAPER, ETC.,
CAN BE ORDERED
TO SUIT CUSTOMERS'
REQUIREMENTS**

CM 504A IMP BANDSAW ATTACHMENT (MAJOR). This illustration shows the 'Imp' Bandsaw mounted as an attachment to the MAJOR. The mounting is similar for the MINOR. In each case, the headstock is swivelled and a pulley is screwed to the spindle nose of machine, and the bandsaw mounted on the saddles. The driving belt between the spindle pulley and the bandsaw is tensioned by sliding the saddle along the bed. It will be noticed from the illustrations here and on the front cover that when the bandsaw is fitted the saw table, planer and thicknesser are also available for instant use.

M 504A IMP BANDSAW ATTACHMENT (MINOR). Similar to above but with different mounting bracket (not interchangeable).

ALSO AVAILABLE AS INDEPENDENT MACHINES. (See separate literature).



Using the deep cutting capacity of the Imp bandsaw to cross cut 7" x 4" timber. Feed rate 12" per minute.

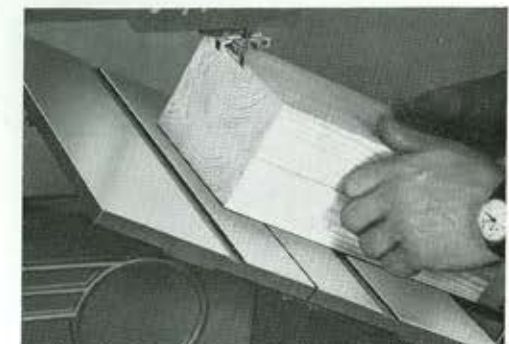

Angle cutting 7" x 4" timber using tilt on saw table. Table tilts to 45° on graduated quadrant.

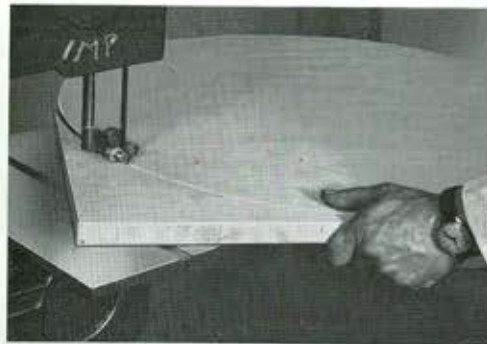

Circles from 16" to 48" diameter may be cut with circular cutting attachment.

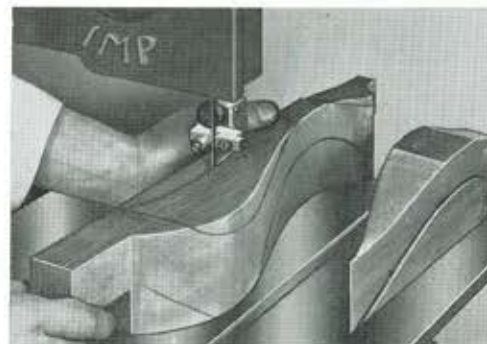

Cabriole legs being cut from square timber. Intricate forms can be cut this way.

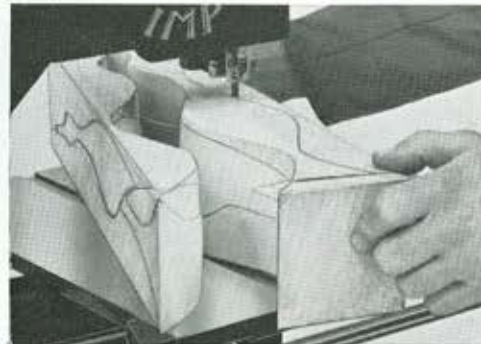

Deep compound cutting of 4" square timber in preparation for wood carving. Feed rate 6" per minute.

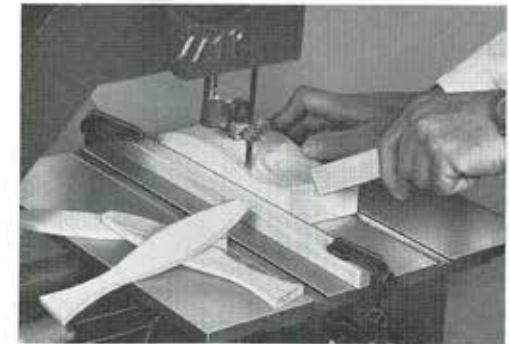

Pad cutting to produce multiples of same shape. Gives wide scope for repetition work.

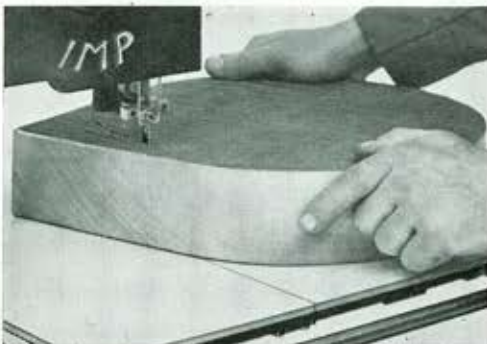

Using false table and jig for circular cutting of 3" hardwood prior to turning.

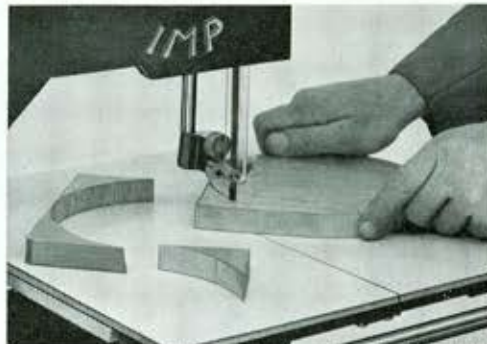

Accurate cutting of 7" circle in 1/2" aluminium using false table and jig, cutting time 4 minutes.

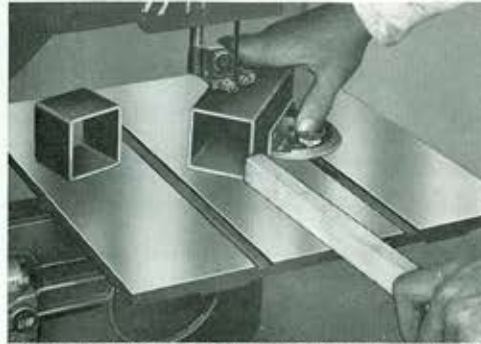

Mitre cutting 2" square 1/4" gauge mild steel tubes, cutting time 2 minutes.

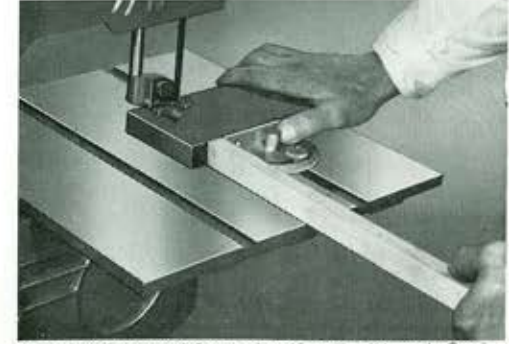

Adopting slow speed for cutting 1" x 4" mild steel. Cutting time 3 minutes.

CIRCULAR SAW TABLE-FITMENTS (Also see page 7)

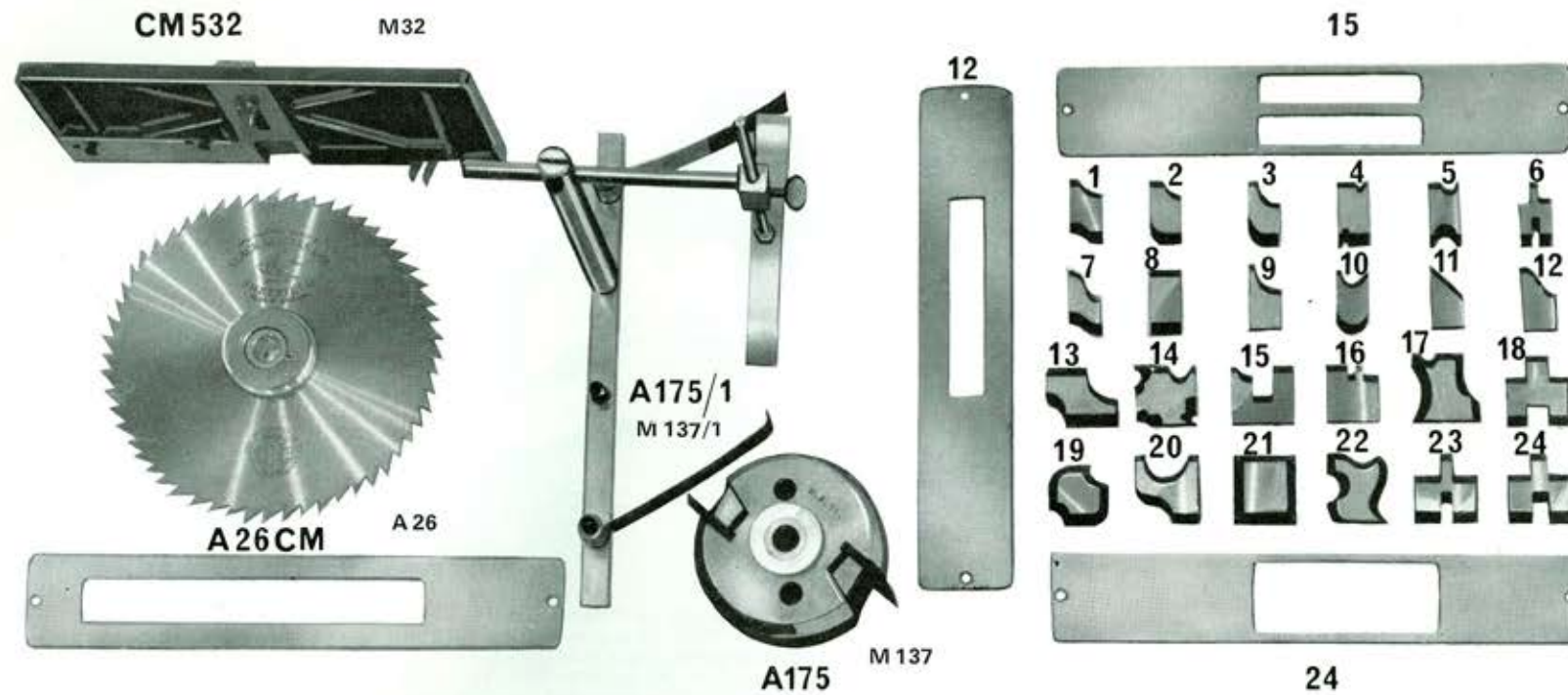

WOBBLE SAW. A26 for Minor 7". A26CM for Major 8".

This saw offers a wide range of uses such as: Grooving, rebating, tenoning, grooved mitres, bridge half-lap and housing joints, etc. The adjustment is infinitely variable by means of the precisely calibrated wobble washers and gives widths of cut from $\frac{1}{8}$ " to $\frac{3}{4}$ " on the 7" and up to $\frac{7}{8}$ " on the 8". The specially designed blade, being of extra thickness, once set, will maintain the width of cut whether grooving or box comb jointing.

COMBING JIG. M32 for Minor. CM532 for Major.

Used in conjunction with the wobble saw, this enables the amateur to produce comb joints of high quality without skill. Timbers of up to 1" thick and of any width or length that can be conveniently handled, can be combed in a matter of seconds.

SPINDLE MOULDING BLOCK. M137 MINOR $3\frac{1}{4}$ " A175 MAJOR $4\frac{1}{2}$ "

There are 24 standard cutters in the range, Nos. 1-12 for the $3\frac{1}{4}$ " and 1-24 for the $4\frac{1}{2}$ ". The part numbers quoted above for the moulding blocks include the saw table insert. No. 15 cutter requires a special insert (part No. 15).

These cutters will produce the variety of mouldings shown on this page permitting the amateur to include intricate designs in his woodworking that would normally only be available to users of very expensive equipment.

Hold Down Springs

These enable the operator to obtain a smooth and even finish to his work as the tension can be adjusted to apply the correct pressure for the work involved, and also avoid the possibility of the work kicking back.

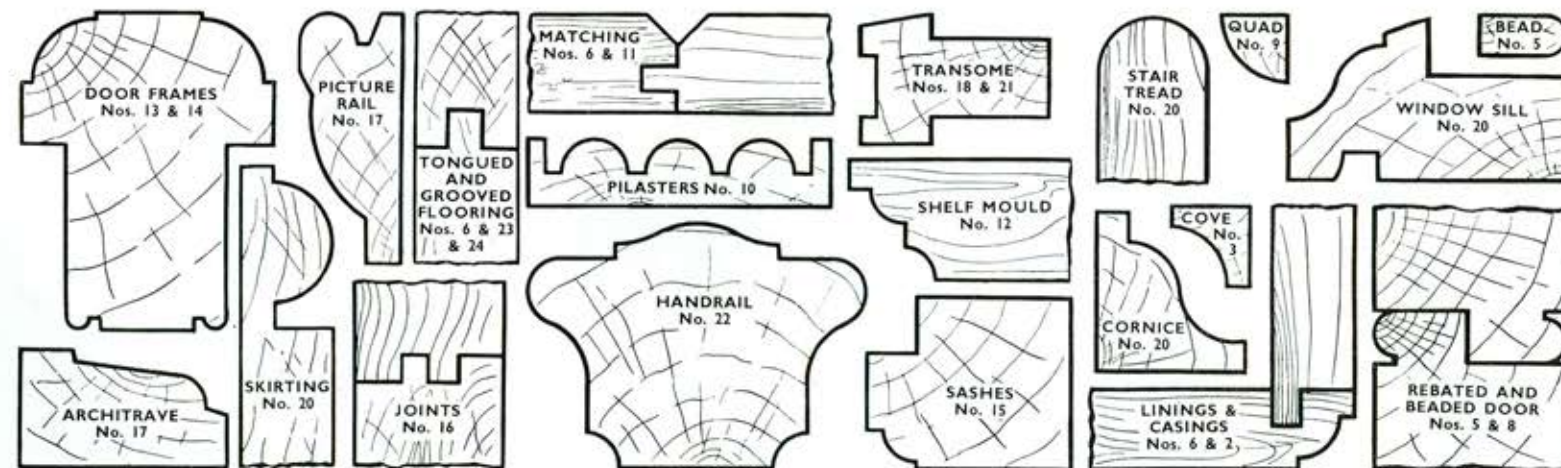

SPINDLE MOULDING SHAPES.

The addition of spindle moulding to a circular saw table extends the use of the table and gives the operator more scope with his projects. With the full range of 24 cutters on the Major saw table, no less than 48 different shapes or sizes can be cut. On the Minor Saw Table, 20 different shapes can be cut using the appropriate 1-12 cutters. The illustrations above show a limited number of these shapes. The correct insert should be used with each cutter, i.e. cutters 1-12 use number 12 insert, cutters 13-24 use number 24 insert, with the exception of number 15, which has its own insert. This insert has additional support in the centre. The Hold Down Springs should be used whenever possible during spindle moulding operations, as the springs can be adjusted to give the correct pressure on your workpiece, holding it firmly to the table and fence, making digital manipulation less necessary. It will be noticed from the illustration on page 7, dealing with spindle moulding, that a hardwood false fence has been added to the rip fence. This is to cover any unwanted portion of the cutters, and gives your moulding a clean edge.

ACCESSORIES FOR TURNING, MORTISING, CIRCULAR SAWING

GENERAL INFORMATION

Faceplates are supplied with lathes, both Major and Minor.

The mounting of discs for bowl turning can be simplified by using the woodscrew chucks. These are made in two sizes, 1½" for work up to 4" diameters, and 2½" for all larger bowls. The turning tools are of best Sheffield steel, and will give good service if ground to a sharp edge and stoned with the A17 slip stone to a fine edge.

The A3 and A30 centres are supplied with the lathes, but additional centres such as A1 four pronged centre and A2 ring centre will be found useful for slender work. The A10a revolving centre is useful when a job is to be turned between centres for a lengthy operation, as it prevents friction between centre and work. The A11 centre extractor is advisable to eject driving centres from headstock. Square hollow chisels are available for the Major range in the four sizes illustrated. The Slot Mortise bits are available for Major or Minor and require top speed for effective working. These bits can be used with the combination table.

The wide variety of saw blades is to cope with the various materials that the woodworker has to handle today. The only universal blade is the tungsten carbide blade. This will outlast several ordinary blades and does not require sharpening as often. The hollow ground blade should be reserved for special work, such as mitres. This blade makes a clean cut equal to planing.

MORTISING ACCESSORIES

SLOT MORTISE CHUCK

Major A24 CM
Minor A24

SLOT MORTISE BITS

Major SM5 ¼" - 7/8"
Minor SM5 ¼" - 3/8"

HOLLOW SQUARE CHISELS

A5 ¼", 5/16", 3/8", ½"
Used on Major only

CHUCKING BUSHES

A5/1 For ¼" Bit
A5/2 For 5/16", 3/8" Bits
A5/3 For ½" Bits
Used with A5 Hollow Square Chisels and Bits.

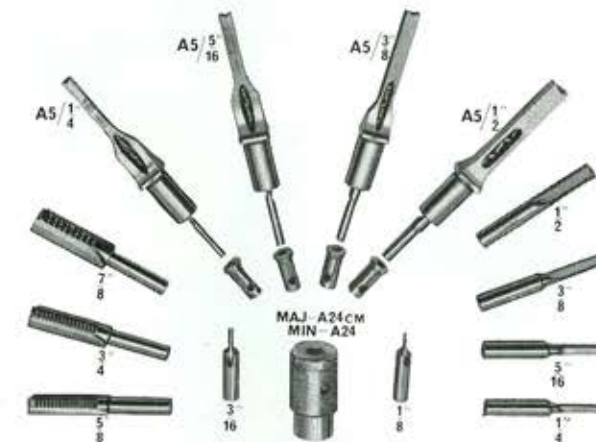

Hollow square chisels are used only on Major equipment, and when set up, the drill should project from the chisel by 1/32" to 1/16". This is to ensure that the chisel has only to square off the bored hole and mortise made by a series of single square holes. Use medium speed. The slot mortise bits are used on top speed for best results. The bit should first be used to make a hole at the beginning of the mortise to full depth, and then withdrawn and re-inserted to a depth equal to the diameter of the cutter (i.e. ¼" diam. — ¼" depth). This will ensure long life and avoid breakages on small sizes. Mortise made by a series of cross cuts at a recommended speed and depth.

TURNING ACCESSORIES

FACEPLATE

Minorette 5" diam. (M 45)
Majorette 6½" diam. (CM 45)

WOODSCREW CHUCK

Major 1½" diam. (CM 511A)
Major 2½" diam. (CM 511A)
Minor 1½" diam. (M 7)
Minor 2½" diam. (M 7)

CENTRE EXTRACTOR

Major (A 11 CM)
Min (A 11)

CENTRES

4 Prong (A1)
2 Prong (A 30)
90° Tailstock (A3)
Cup (A2)
Revolving (A10 A)

WOOD TURNING TOOLS

Set of 6 (A 21)

SLIP STONE

4" x 1½" complete with case (A 17)

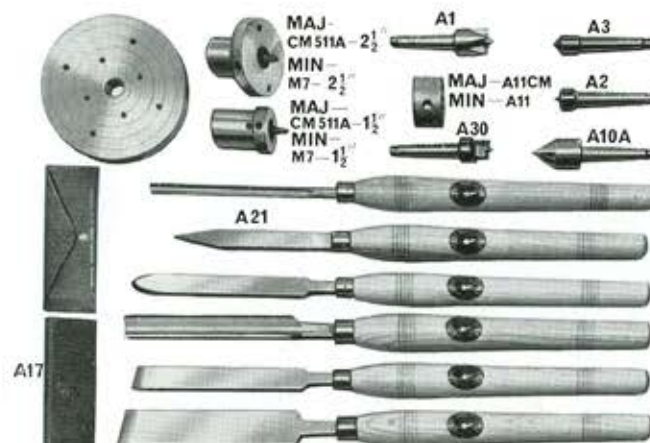

CIRCULAR SAW BLADES

- No. 1 Very Fine.
- No. 2 Medium.
- No. 3 Hollow Ground Novelty.
- No. 4 Wobble Saw 7" and 8".
- No. 5 Flat Ground Novelty.
- No. 6 Rip.
- No. 7 Cross Cut.
- No. 8 Tungsten Tipped.
(for long life and smooth finish)

Major 10".
Minor 7".

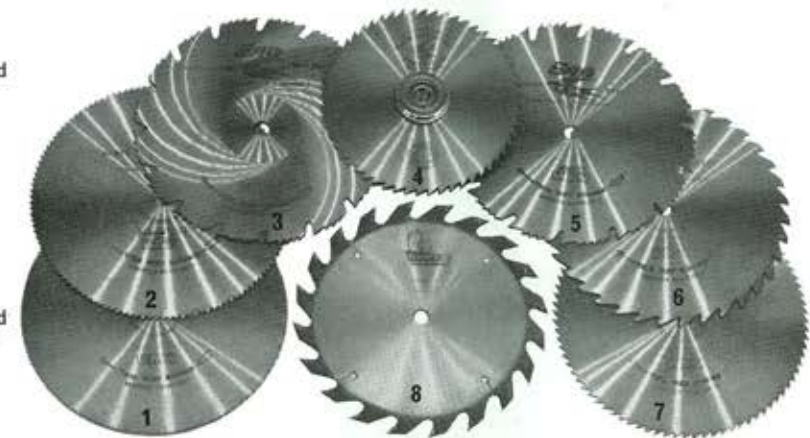

USES OF CIRCULAR SAW BLADES

The range of circular saw blades is designed to meet the requirements of all woodworking operations. The very fine blade will cut the thinnest plywood and panels without 'spelching' it. The medium blade is for blockboard, chipboard, etc. The cross cut blade is for what the title suggests, crosscutting timber. A good general purpose blade is the flat ground blade, this incorporates both rip and cross cut teeth. The rip blade is ideal for all cutting with the grain, and general purpose work. For the finest finish for cross cuts, mitres, etc., the hollow ground blade is the best. The tungsten carbide toothed blade will both rip and cross cut timber, and has an exceedingly long life between re-sharpening, this is the best blade to buy for all round work. The wobble saw will cut a groove from 1/8" to 3/4" wide.

ACCESSORIES—GUARDS, MOTORS, SANDING REQUISITES

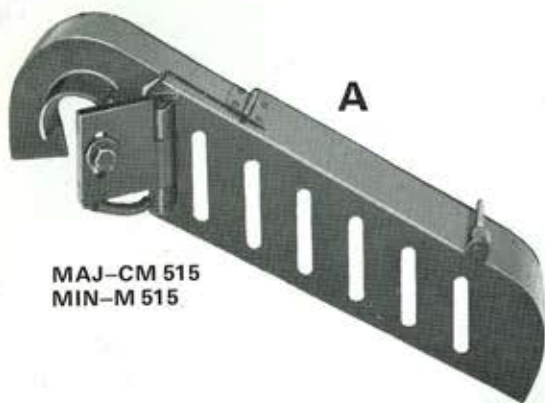

MAJ-CM 515
MIN-M 515

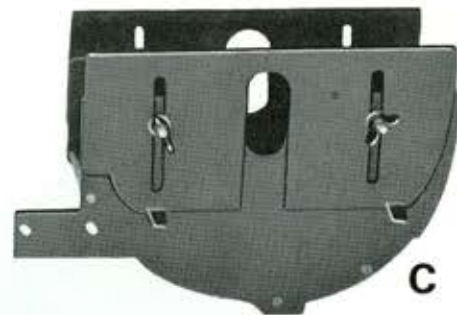

MAJ-CM 516
MIN-M 516

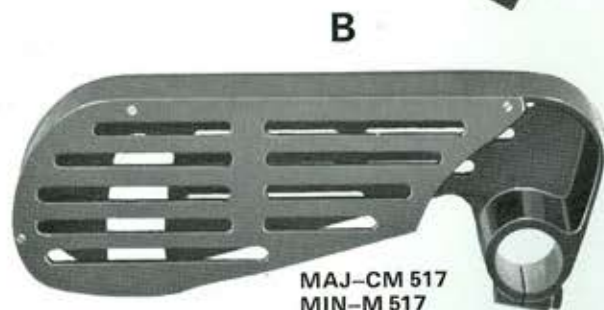

MAJ-CM 517
MIN-M 517



MAJ-CM/512/1
MIN-M8/1



MAJ-CM 501/1

SELF CONTAINED MOTOR PLATFORM



MIN-M6
MOTOR
PLATFORM



MAJ.GEARBOX
GM501A

MIN.GEARBOX
M5A

MAJ-CM 501-HP STD MOTOR 2850r.p.m.
MIN-M 5-1/2 HP STD MOTOR 2850r.p.m.



A. HEADSTOCK BELT GUARD

Major CM515
Minor M515

B. PLANER BELT GUARD

Major CM517
Minor M517

C. UNDERSIDE SAW GUARD

Major CM516
Minor M516

D. GRINDSTONE GUARD AND REST

Major CM 512/1
Minor M8/1

E. MAJOR MOTOR PLATFORM

CM501/1

F. MINOR MOTOR PLATFORM

M6

G. 1 H.P. MOTOR 2850 R.P.M.

Major CM501

H. 4-1 RATIO GEAR BOX

Major CM 501A
Minor M5A

I. 1/2 H.P. MOTOR 2850 R.P.M.

Minor M5

J. GRINDSTONE

A25

K. GRINDSTONE ARBOR

Major CM518
Minor M8

L. DISC ADHESIVE

A9

M. SANDING DISCS

A7/6 1/2"

O. SANDING DISCS

A7/8"

P. SANDING DISCS

A7/14"

Q. SLIP STONE

A25"1

R. POLISH MOP ARBOR

Major CM514
Minor M16

S. POLISH MOP

A12

T. SANDING BELTS

A8/4"

U. SANDING BELTS

A8/6"

V. MOUNTED POINT

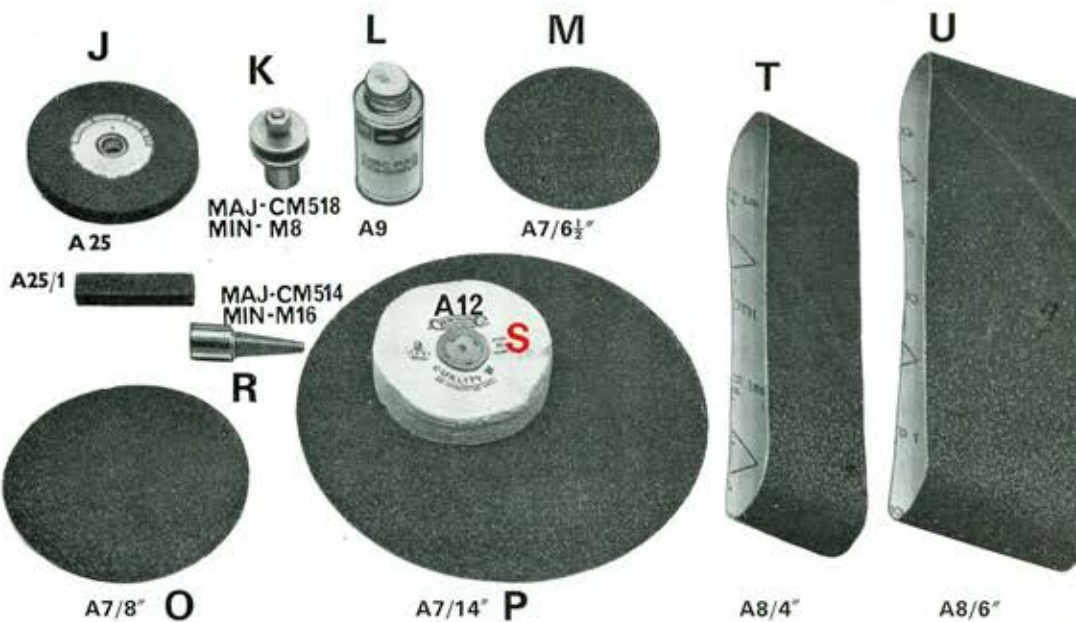

J

A 25

K

MAJ-CM518
MIN-M8

L

A9

M

A7/6 1/2"

T

A8/4"

U

A8/6"

A25/1

MAJ-CM514
MIN-M16

R

A7/8"

A7/14" P

V

SWIVEL HEADSTOCK

CORNER DIAGRAMS SHOW RELATIONSHIP OF HEADSTOCK TO BED

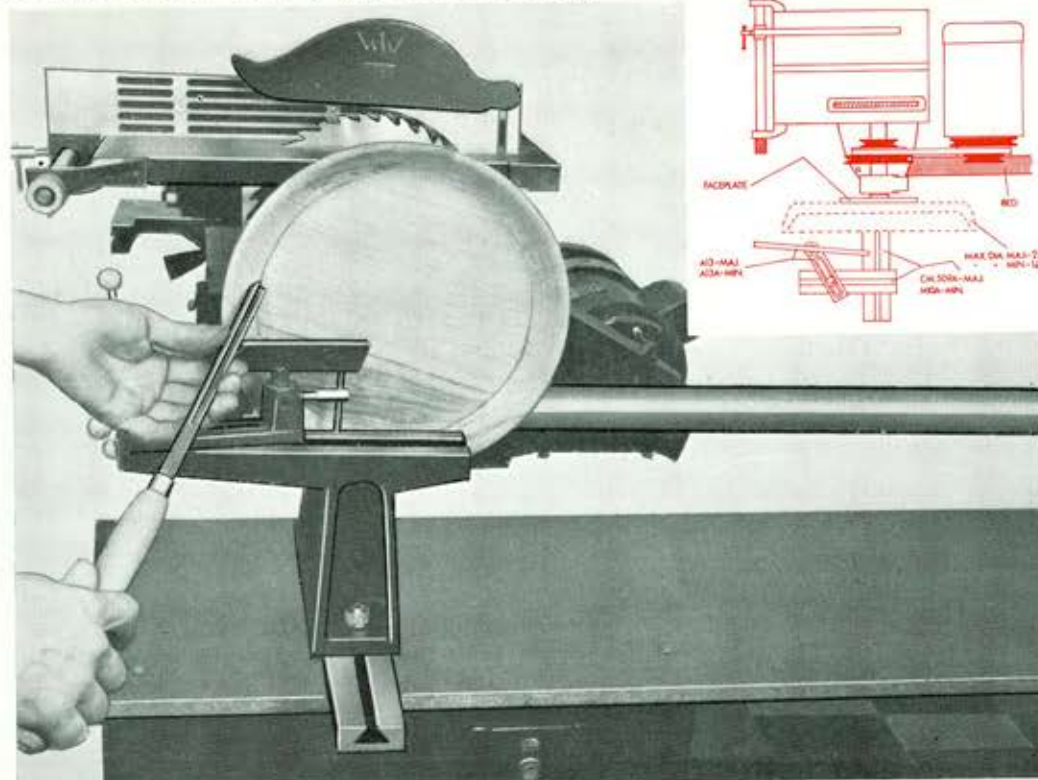

Large diameter bowl turning (see page 12) with headstock swivelled 90° and using special rest CM509A or M10A.

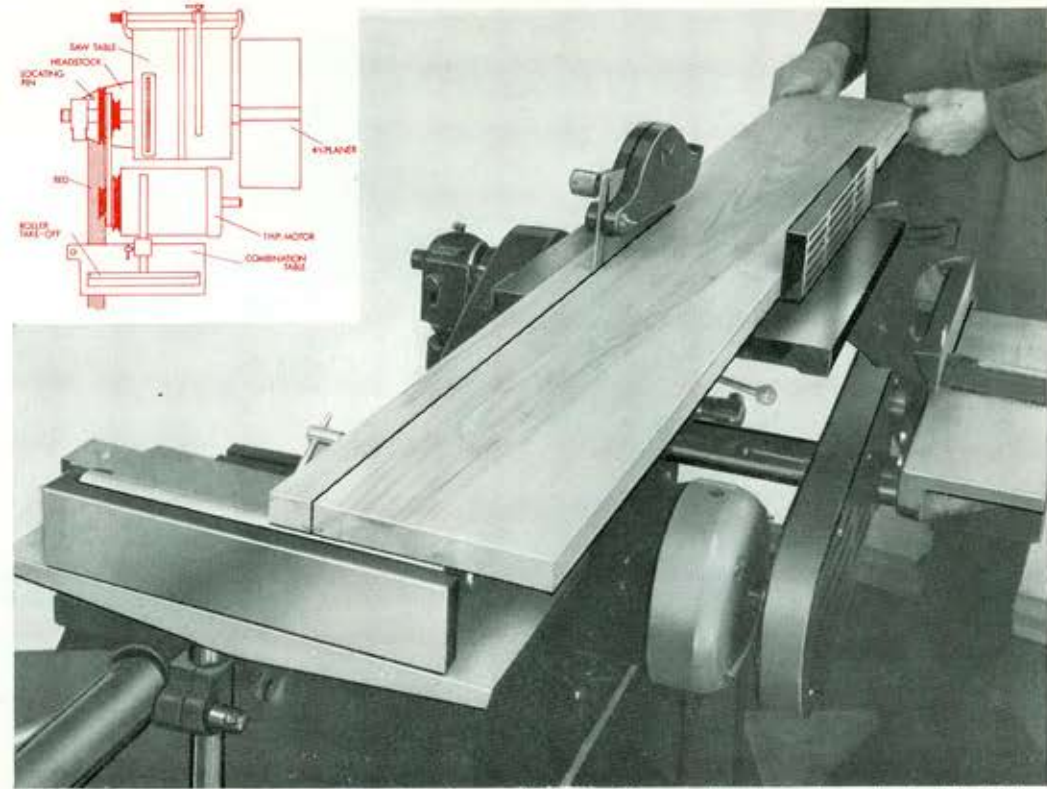

Ripping long timbers (see page 6) headstock swivelled 90° using combination table as 'take off table' CM519A or M9.

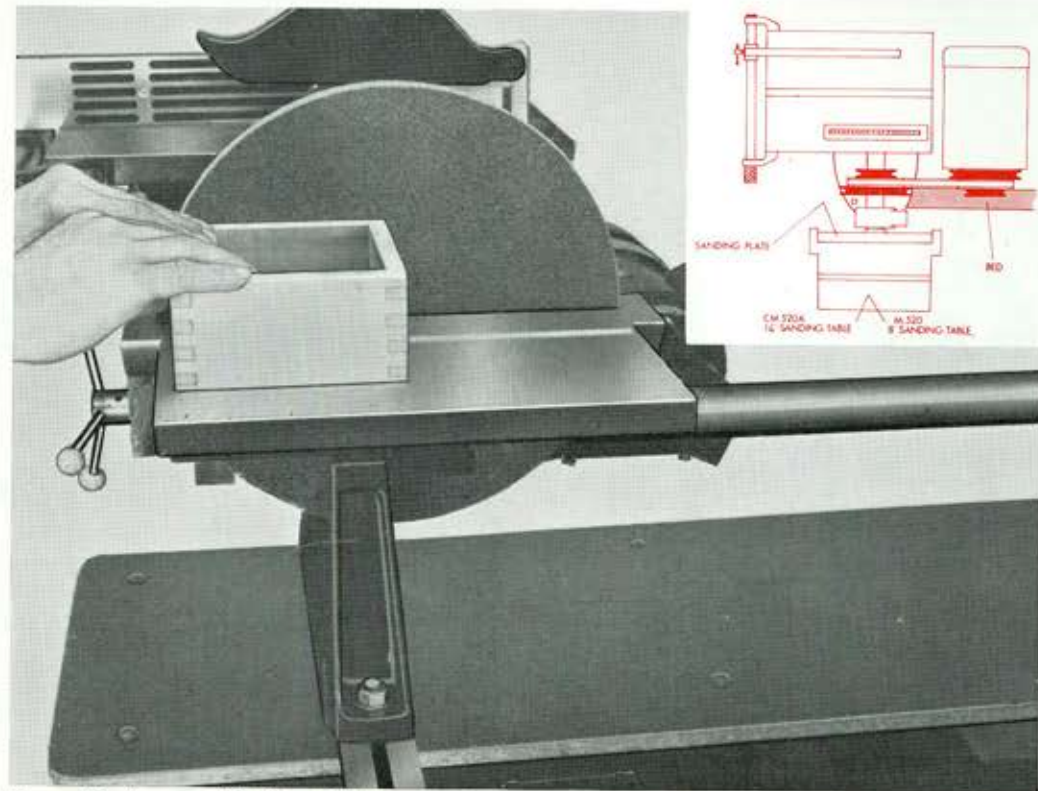

Disc sanding (see page 10) 8" or 14" diameter, headstock swivelled 90° used with special rest as above, standard CM520 8", CM520A 14" or M508 8".

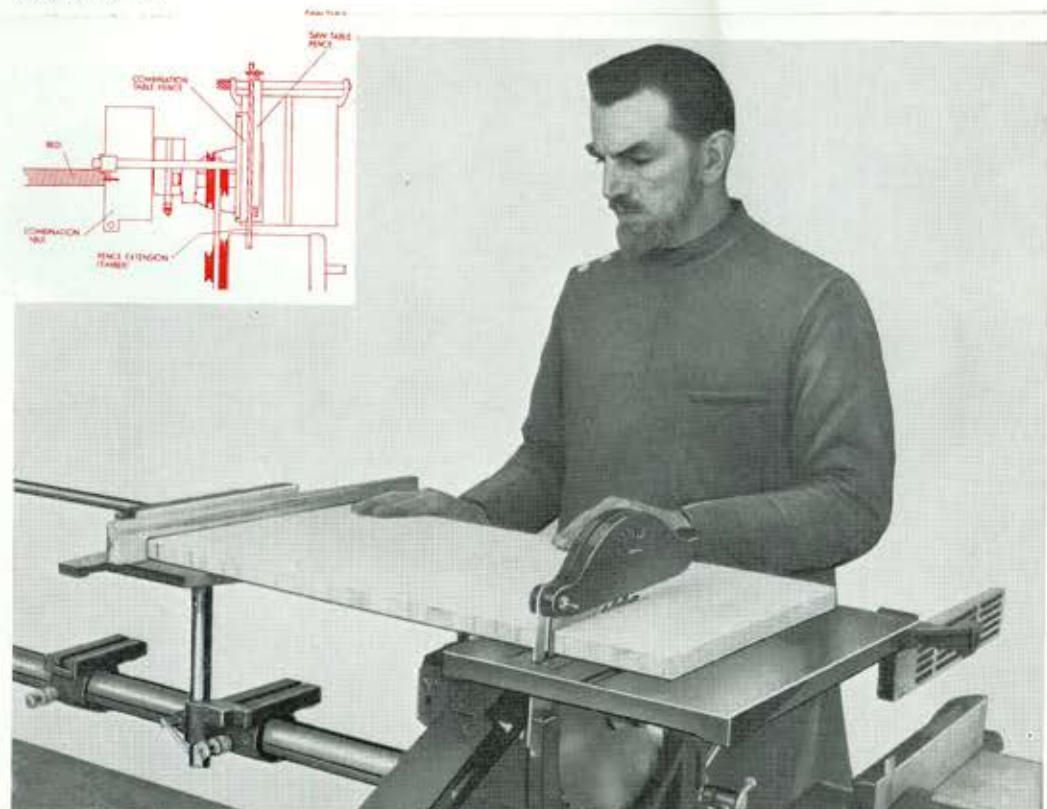

Panel cutting (see page 6) to square up combination table fence with saw blade, adjust so that both fence 'kiss' before locking and adjusting for width (see corner diagram).



CORONET TOOL CO

ALFRETON ROAD · DERBY Telephone: 47508 and 42606

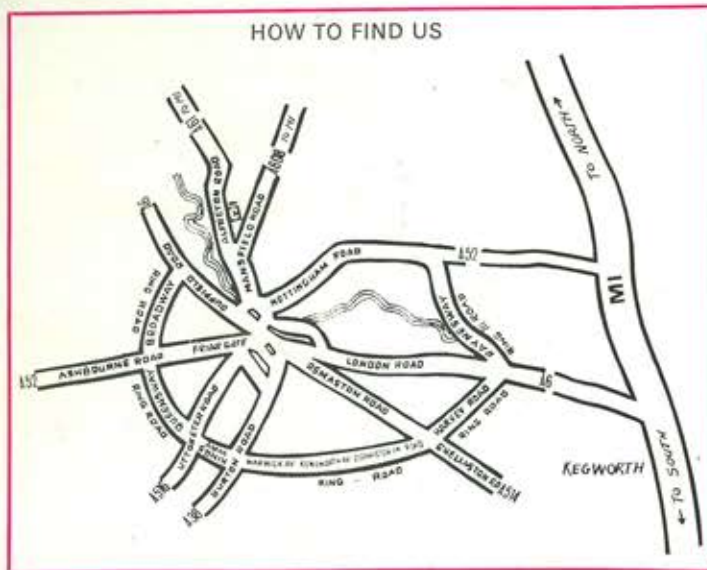

CORONET AT DERBY

To support our stockists we have full demonstration facilities for the Coronet range at our extensive Derby Showroom. Please refer to our price list for details.

ILLUSTRATED

- TOP Show windows featuring lathes, attachments and accessories.
- LOWER LEFT Demonstration area.
- LOWER CENTRE Film and lecture theatre.
- LOWER RIGHT Main entrance and reception.

